



1
9
9
6

Membrane Interface Probe (MIP)

Direct Image® tools vertically log soil characteristics in-situ such as:

- lithology
- electrical conductivity
- permeability
- various other geotechnical parameters
- VOC contaminant content
- hydrocarbon fluorescence

Data generated from the probe sensors can be combined to create accurate, highly detailed conceptual site models...the critical first step in any site investigation.



MIHPT Probe

INDUSTRY FIRST



2
0
0
6

Hydraulic Profiling Tool



2
0
1
2

MIHPT

Geoprobe® Direct Image® Systems

Technology	Expanded Name	Primary Purpose	Usage	Commonly Combined Sensors	ASTM Standards
MIP	Membrane Interface Probe	VOC detection	Separate detection of chlorinated and non chlorinated species, contaminant depth, and relative concentration. Used to map dissolved phase plume extents or find source zones.	EC, HPT	D7352-07 (2018)
OIP-UV	Optical Imaging Profiler - Ultraviolet (275nm and Visible Light)	Non aqueous phase hydrocarbons by UV fluorescence	Fluorescence detection of hydrocarbon fuels and oils. Visible light used for indication of soil color and texture.	EC, HPT	
OIP-G	Optical Imaging Profiler - Green (520nm and Infrared Light)	Non-aqueous phase (heavy) hydrocarbons fluorescing with green light	Fluorescence detection of coal tars, creosotes, bunker fuels, residual fuel oils, and crude oils.	EC, HPT	
HPT	Hydraulic Profiling Tool	Relative soil permeability	Piezometric head, water table depth, estimated K, estimated GW specific conductance in sands and determination of contaminant migration pathways.	EC, MIP, OIP	D8037 D8037M-16
EC	Electrical Conductivity	Bulk formation electrical conductivity	Used as a proxy for lithology and for detection of ionic contamination. EC is most often used as an add-on sensor to other logging tools.	HPT, MIP, OIP	
CPT	Cone Penetration Testing NEW: Seismic CPT	Mechanical behavior of soils	Soil property measurements of cone tip resistance, sleeve friction, and pore pressure. These measurements can be used to determine soil geotechnical parameters.	EC, MIP, HPT or OIP	D3441
PST	Pneumatic Slug Testing	Hydraulic conductivity (K)	Groundwater flow rates for estimate of contaminant migration.		D7242 D7242M-06

Soil imaging probe and method of processing soil image to detect hydrocarbon contamination manufactured under US Patents 10,371,637 and 10,739,264

geoprobe.com/mip

Direct Image® Logging Tools

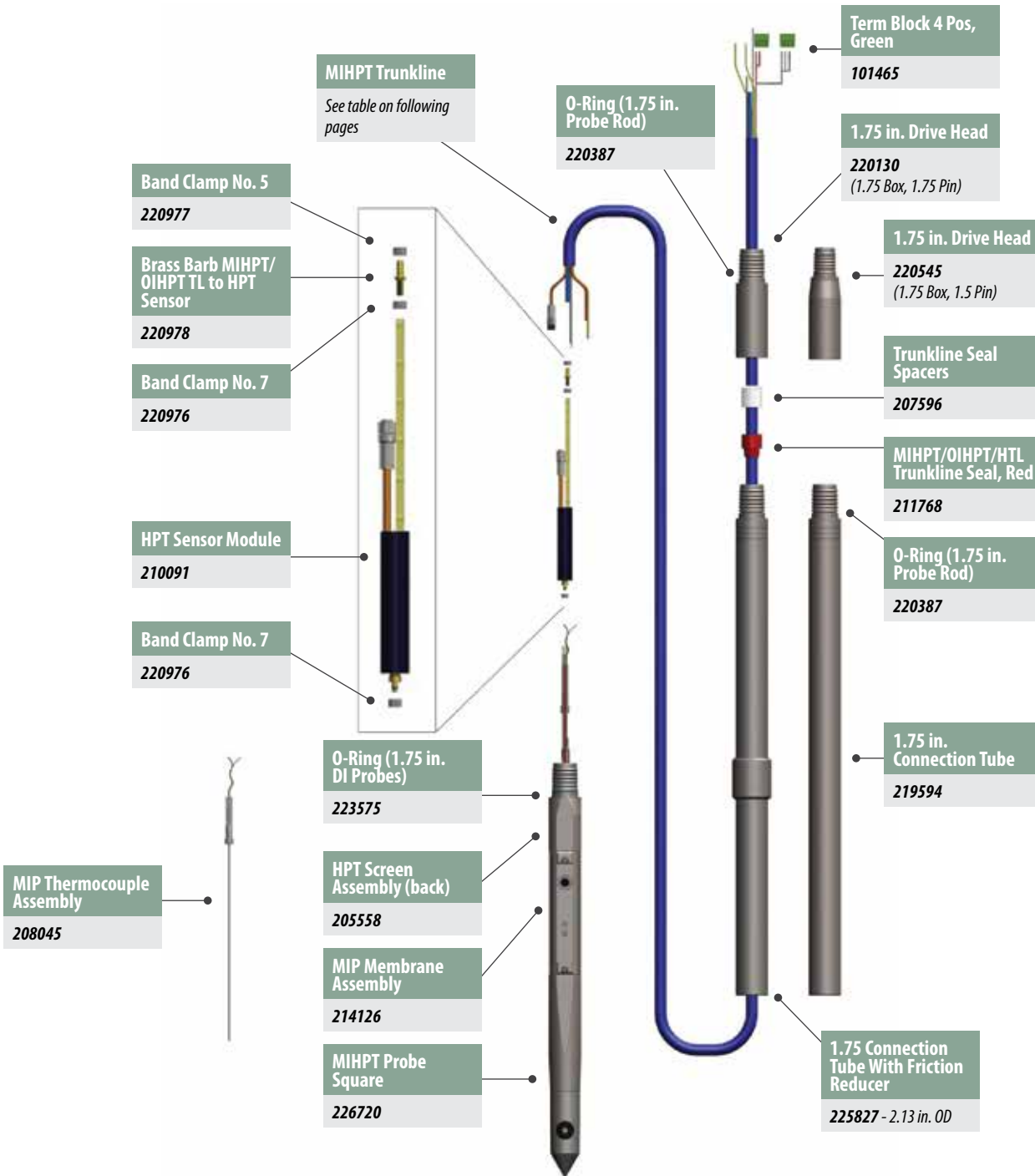

Note

CPT options are available in the *OIHPT/MIHPT - CPT Sub* section

MIP Overview

geoprobe.com/mip



Learn the benefits of using the MIP system to log VOCs with depth in soil.





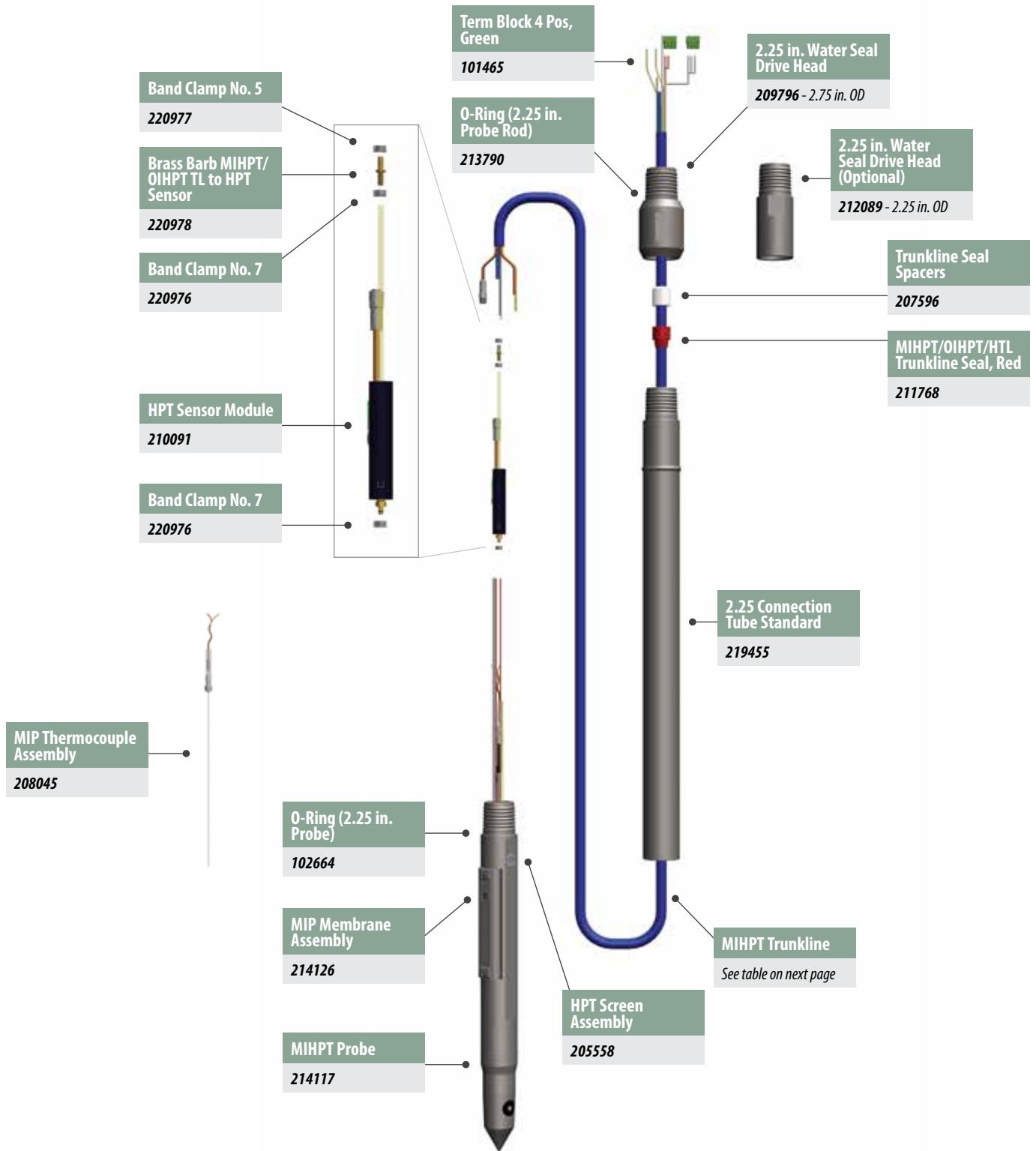

VIDEO

geoprobe.com/mip

Direct Image® Logging Tools





Detectors, Instruments, Controllers

Components	Part	MN	Notes
	MIP Detector System	213947	110V
		213946	220V
	Field Instrument	213940	110V
		213941	220V
	MIP Controller	214137	110V
		214139	220V
	HPT Flow Controller	214091	110V
		214093	220V
	MIP Pulse Flow Controller	216030	110-220V
	Heated Trunkline Controller	214147	110V
		214148	220V



Probes

Components	Part	MN	Notes
	MIHPT Probe Square	226720	1.75 in.
	MIHPT Probe	214117	2.25 in.















Trunklines & Accessories

Components	Part	MN	Notes
	MIP Trunkline	204077	100 ft.
		202570	150 ft.
		204655	200 ft.
	MIHPT Trunkline	236309	100 ft.
		236310	150 ft.
		236311	200 ft.
	MIP Heated Trunkline	214150	100 ft.
		214151	150 ft.
	MIP Heated Transfer Line	214149	8 ft.
	MIP/OIP Trunkline Seal, Yellow	207773	
	MIHPT/OIHPT/HTL Trunkline Seal, Red	211768	
	Trunkline Seal Spacers	207596	Pair

Accessories

Components	Part	MN	Notes
	MIP Service Kit	214142	
	HPT Service Kit	205599	
	MIP Thermocouple Assembly	208045	
	MIP Membrane Assembly	214126	
	Copper Washer Seal	102520	0.79 in. OD
	HPT Screen Assembly	205558	

Accessories (continued)

Components	Part	MN	Notes
	HPT Spring Washer	215453	Quantity: 10
	MIP-HPT Screen Ratchet Wrench Assembly	212094	
	MIP-HPT Screen Ratchet Wrench Head Assembly	212095	
	HPT Sensor Module	210091	
	Band Clamp No. 7	220976	Quantity: 10
	Band Clamp No. 5	220977	Quantity: 10
	Brass Barb MIHPT/OIHPT TL to HPT Sensor	220978	Quantity: 5
	O-Ring (1.75 in. Probe Rod)	220387	Quantity: 25
	O-Ring (1.75 in. DI Probes)	223575	Quantity: 10
	O-Ring (2.25 in. DI Probes)	220388	Quantity: 10
	Ferrule 1/16 in. x .8 mm Graphite/Vespel	108116	
	Ferrule Set Brass 1/16 in.	210555	Quantity: 10
	Nut Hex BRS 1/16 in. Comp Tube	210557	Quantity: 10
	Nut Hex BRS 1/8 in. Comp Tube Swagelok	102071	
	MIP 120V TL Heater Connector	112805	
	Conn Thermocouple "K" Type Male	101498	
	Term Block 4 Pos, Green	101465	
	MP6520 Probe Butt Conn Green	208657	Quantity: 10
	MP6520 Probe Butt Conn Red	208658	Quantity: 10
	EC Dipole Tester	205724	
	HPT Reference Cylinder	212689	For 1.75 in. and smaller probes
	HPT Reference Cylinder	211762	For 2.25 in. probes
	MIP Breakout Connection Panel	211100	
	Flow Meter Digital MIP	600227	
	Flow Meter ADM Cartridge	114654	NEW
	XSD Probe Assembly	112878	
	XSD Reactor Core	213495	
	PID Lamp Model #108-10.0/10.6	600044	
	MIP Soil Gas Response Test Jig	231500	
	MIP Nafion Dryer Tube	600150	SS, 24 in. LG

geoprobe.com/oip

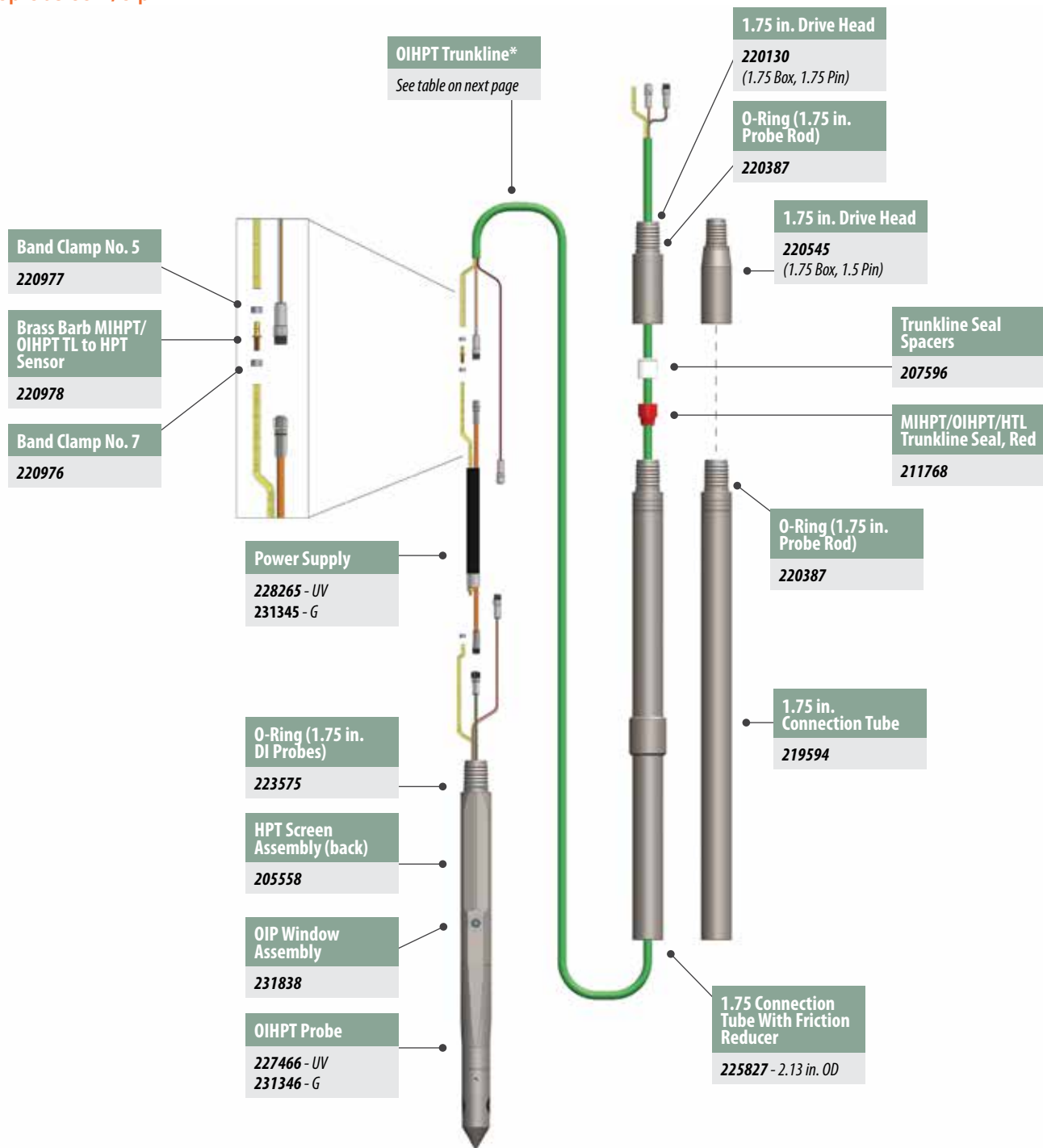

*Switching from UV to G is a swap of the probe and power supply.

Running OIP without HPT

To run OIP without HPT, you need to plug off the HPT port on the probe (HPT Port Plug 226700) and use the tools above.

Note

CPT options are available in the OIHPT/MIHPT – CPT Sub section

Soil imaging probe and method of processing soil image to detect hydrocarbon contamination manufactured under US Patents 10,371,637 and 10,739,264

Instruments, Controllers

Components	Part	MN	Notes
	Field Instrument	213940	110V
		213941	220V
	OIP Interface	224720	100-220VAC
	HPT Flow Controller	214091	110V
		214093	220V

Probes

Components	Part	MN	Notes
	OIHPT-UV Probe	227466	UV275
		231346	GL525

Trunklines & Accessories

Components	Part	MN	Notes
	OIHPT Trunkline	228253	100 ft.
		228254	150 ft.
		231482	200 ft.
	OIHPT-UV Power Supply	228265	
		231345	
	Trunkline Seal Spacers	207596	Pair
		MIHPT/OIHPT/HTL Trunkline Seal, Red	211768

1.75 in. Components

Components	Part	MN	Notes
	1.75 RHSL Box x 1.75 RHML Pin	220130	4.08 in. S-S
	O-Ring (1.75 in. Probe Rod)	220387	Quantity: 25
	1.75 in. Drive Head	220545	1.75 Box x 1.5 Pin
	O-Ring (1.5 in. Probe Rod)	202695	Quantity: 25
	1.75 Connection Tube With Friction Reducer	225827	2.13 in. OD
	1.75 in. Connection Tube	219594	

S-S (Shoulder to Shoulder)

Accessories

Components	Part	MN	Notes
	OIP Window Assembly	231838	4 mm
	O-Ring (1.75 in. DI Probes)	223575	Quantity: 10
	OIP Window Seals	224959	Quantity: 10
	OIP Window Ratchet Wrench Assembly	225140	
	OIP Window Ratchet Wrench Head Assembly	225139	
	MIP-HPT Screen Ratchet Wrench Assembly	212094	
	MIP-HPT Screen Ratchet Wrench Head Assembly	212095	
	Four Sided Cuvette Holder Assembly	225952	
	Cuvette Quartz 3500 uL	112784	Quantity: 2
	EC Dipole Tester	205724	
	OIP Service Kit	226361	
	HPT Service Kit	205599	
	OIP Test Load	228240	
	OIP Trunkline Pigtail	227458	Down Hole End
	OIP Trunkline Pigtail	227459	Down Hole End
	OIP Trunkline Pigtail	227461	Up Hole End
	OIP Trunkline Pigtail	227462	Up Hole End
	Brass Barb MIHPT/OIHPT TL to HPT Sensor	220978	Quantity: 5
	Band Clamp No. 7	220976	Quantity: 10
	Band Clamp No. 5	220977	Quantity: 10
	HPT Reference Cylinder	212689	For 1.75 in. and smaller probes
	HPT Reference Cylinder	211762	For 2.25 in. probes
	1.75 in. Solid Drive Point	222652	2.0 in. OD
	1.5 in. Solid Drive Point	202637	1.7 in. OD

OIHPT Step-by-Step

geoprobe.com/oip



This step-by-step demo goes through setup and sampling with the OIHPT system.

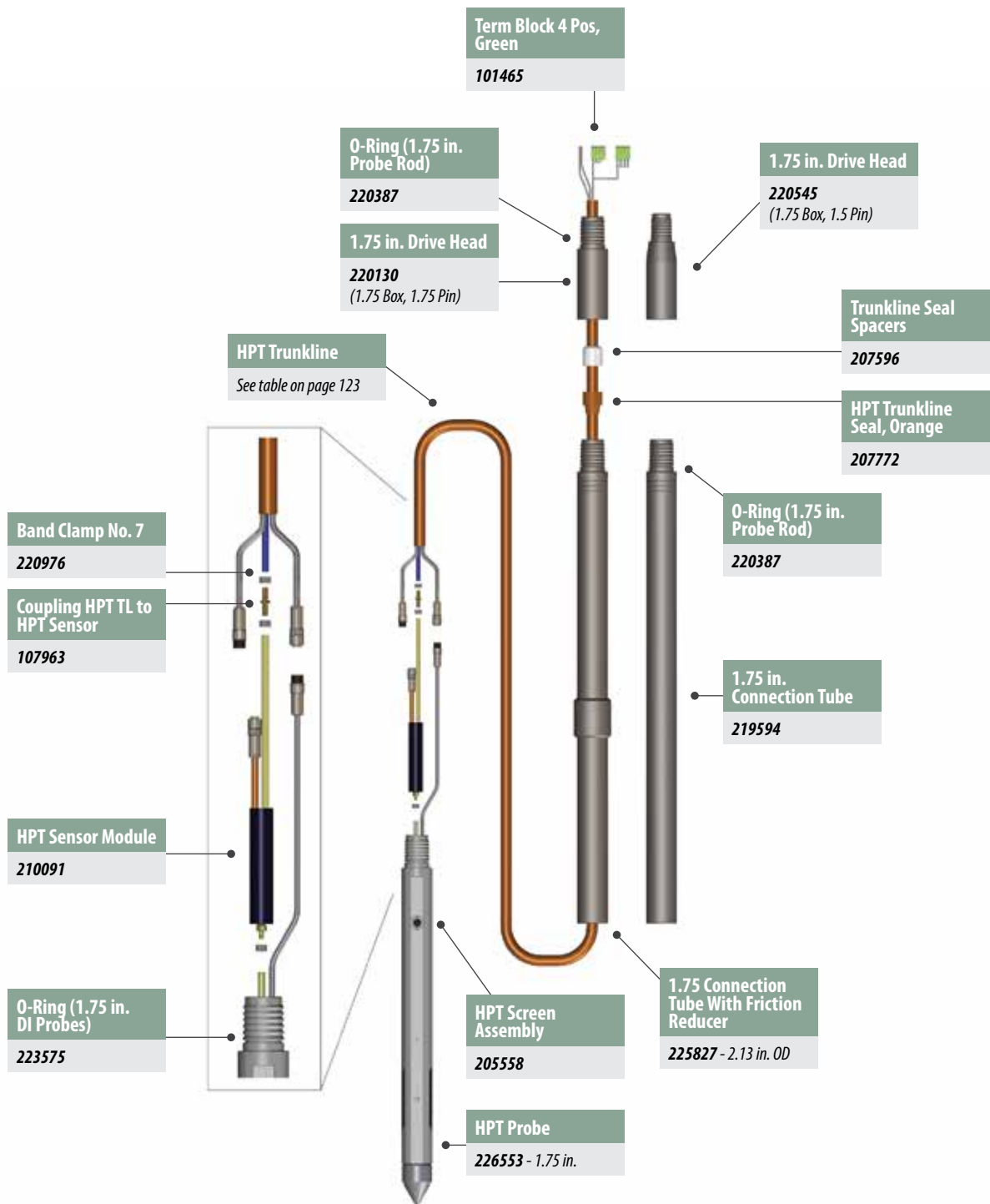

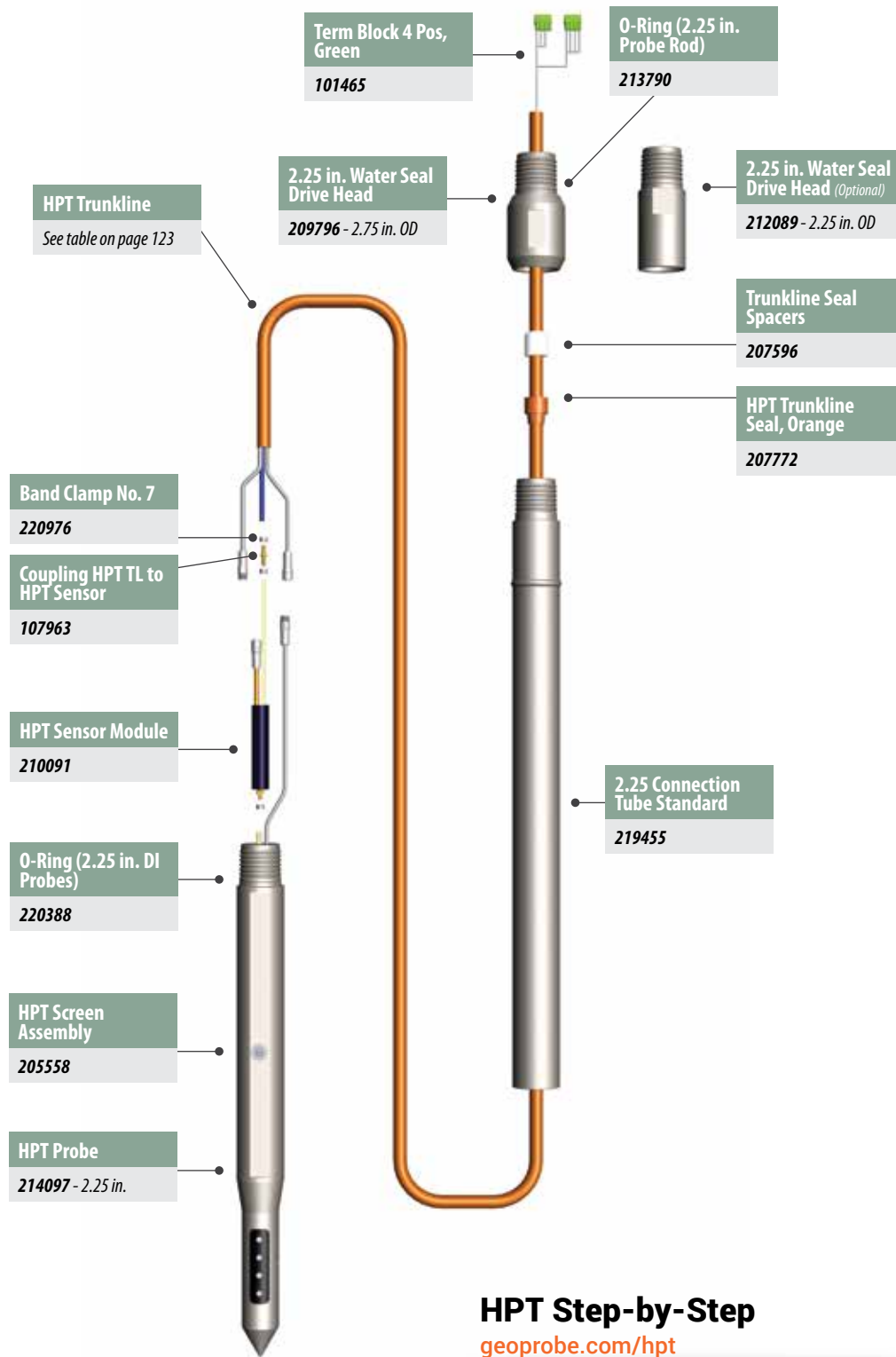

HPT Step-by-Step

geoprobe.com/hpt



Learn how to log using the HPT system in this step-by-step video.

Instruments, Controllers

Components	Part	MN	Notes
	Field Instrument	213940	110V
		213941	220V
	HPT Flow Controller	214091	110V
		214093	220V

Probes

Components	Part	MN	Notes
	HPT Probe	226553	1.75 in.
	HPT Probe	214097	2.25 in.

Trunklines & Accessories

Components	Part	MN	Notes
	HPT Trunkline	214095	150 ft.
		214096	200 ft.
	HPT Trunkline Seal, Orange	207772	
	Trunkline Seal Spacers	207596	Pair

Accessories

Components	Part	MN	Notes
	HPT Service Kit	205599	
	HPT Screen Assembly	205558	
	HPT Spring Washer	215453	Quantity: 10
	HPT Sensor Module	210091	
	Coupling HPT TL to HPT Sensor	107963	
	Band Clamp No. 7	220976	Quantity: 10
	MIP-HPT Screen Ratchet Wrench Assembly	212094	
	MIP-HPT Screen Ratchet Wrench Head Assembly	212095	
	HPT Reference Cylinder	212689	For 1.75 in. and smaller probes
	HPT Reference Cylinder	211762	For 2.25 in. probes
	Wenner Array Probe Test Jig	214237	
	EC Test Load, 3 Level Test	208075	
	HPT Controller Test Load	206552	
	140 Micron Filter Replacement HPT	110223	
	HPT Trunkline - EC Pigtail	220974	
	HPT Trunkline - Sensor Pigtail	220975	
	Term Block 4 Pos, Green	101465	
	HPT Line Pressure Sensor	112735	
	HPT Flow Sensor	106479	

1.75 in. & 2.25 in. Components

Components	Part	MN	Notes
	1.75 RHSL Box x 1.75 RHML Pin	220130	4.08 in. S-S
	O-Ring (1.75 in. Probe Rod)	220387	Quantity: 25
	1.75 in. Drive Head	220545	1.75 Box x 1.5 Pin
	O-Ring (1.5 in. Probe Rod)	202695	Quantity: 25
	1.75 Connection Tube With Friction Reducer	225827	2.13 in. OD
	1.75 in. Connection Tube	219594	
	O-Ring (1.75 in. DI Probes)	223575	Quantity: 10
	O-Ring (2.25 in. Probe Rod)	213790	Quantity: 25
	2.25 in. Water Seal Drive Head	209796	2.75 in. OD
	2.25 in. Water Seal Drive Head	212089	2.25 in. OD
	2.25 Connection Tube Standard	219455	
	O-Ring (2.25 in. DI Probes)	220388	Quantity: 10

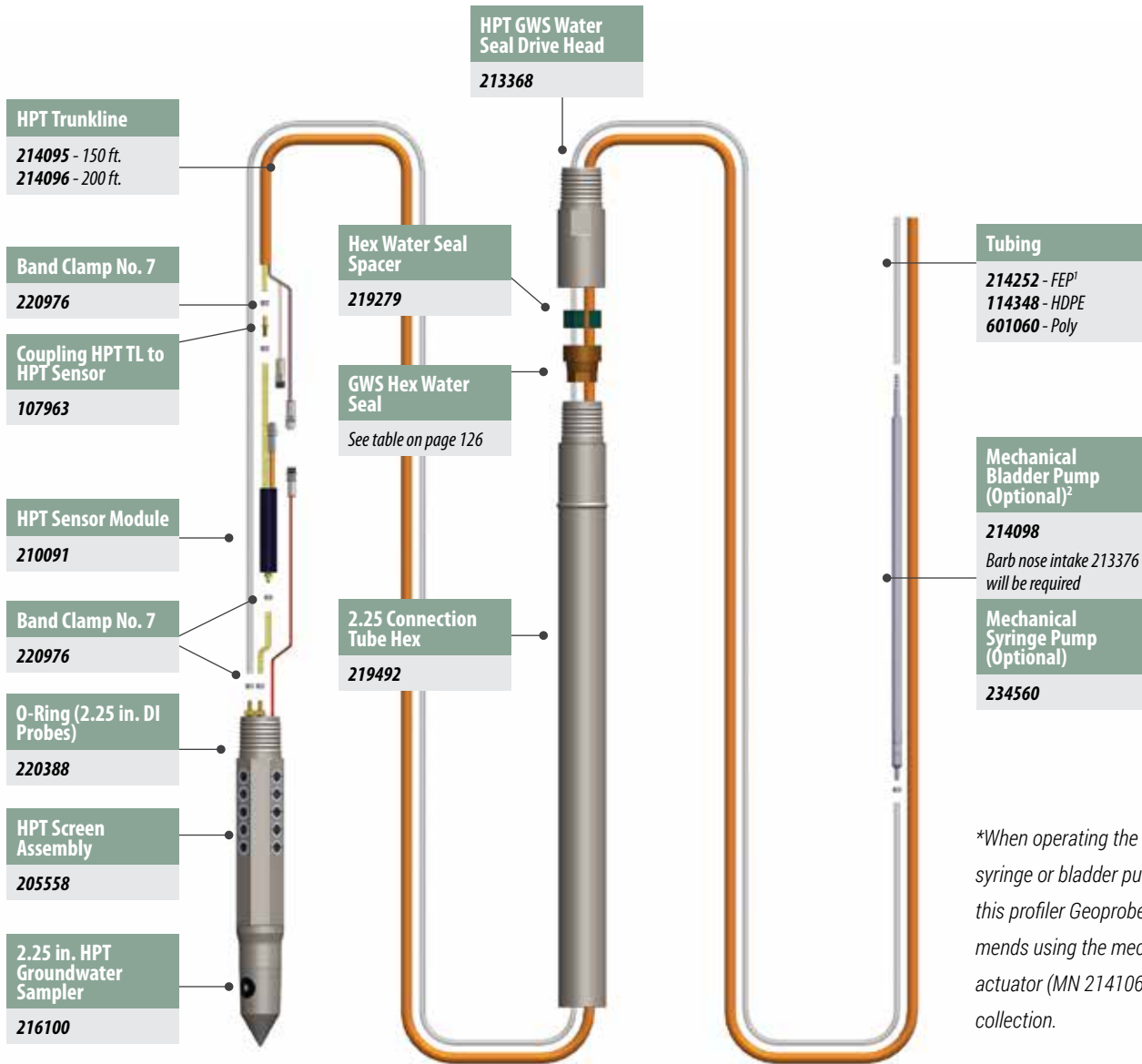

*When operating the mechanical syringe or bladder pump within this profiler Geoprobe® recommends using the mechanical actuator (MN 214106) for sample collection.

¹Not recommended for PFAS sampling.

²Recommended for VOC sampling except when sampling > 5 samples per boring.

geoprobe.com/1.75gw

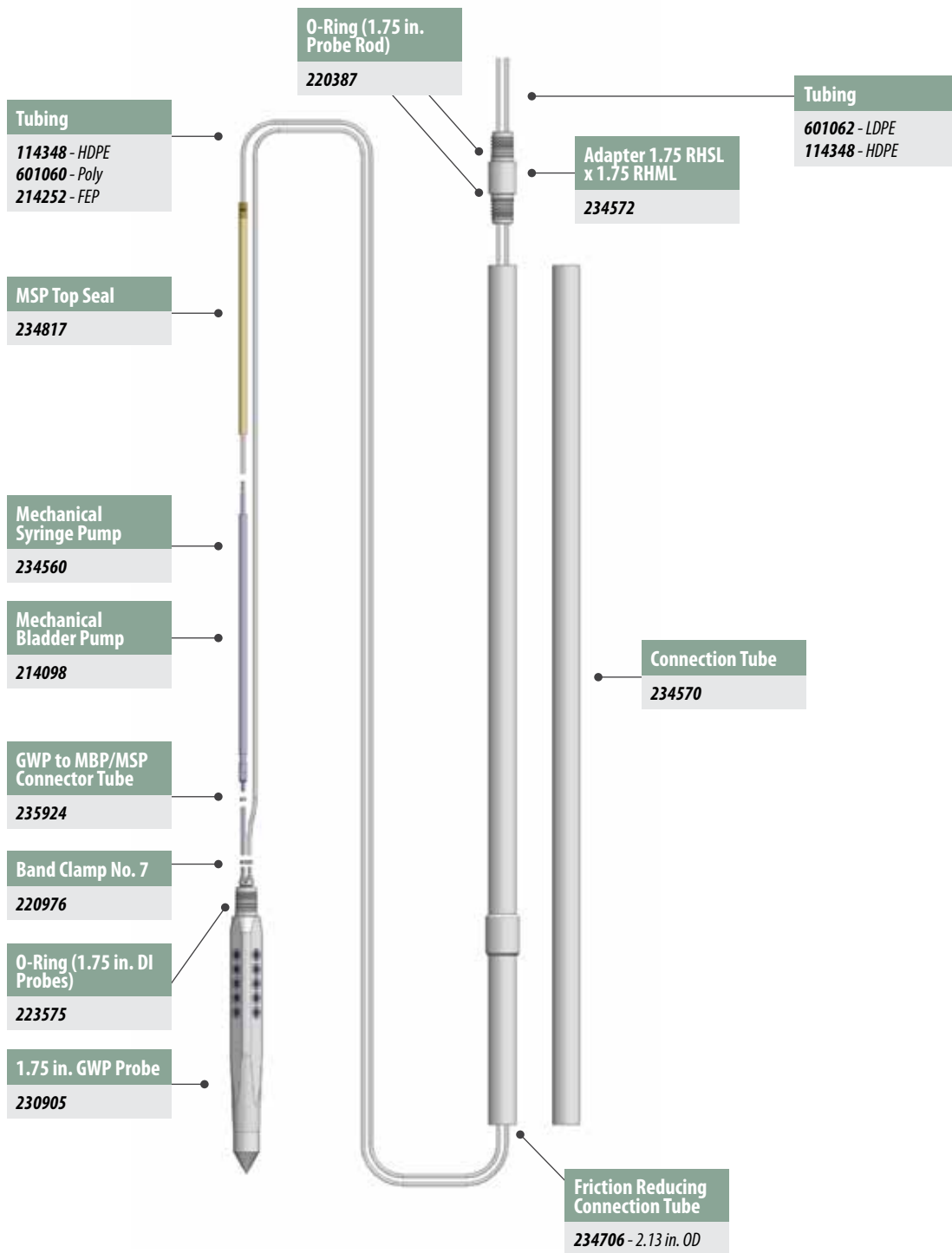

NOTE: When shallow groundwater conditions are present the 175GWP may be operated with a peristaltic pump from the surface. In this case a down hole pump is not used. With this setup the standard length 1.75-in. connection tubes (219594 or 225827 with friction reducer) may be used.

When operating the mechanical syringe or bladder pump within this profiler Geoprobe® recommends using the mechanical actuator (MN 214106) for sample collection.

HPT-GWS

Probes

Components	Part	MN	Notes
	2.25 in. HPT Groundwater Sampler	216100	

Accessories

Components	Part	MN	Notes
	2.25 Connection Tube Hex	219492	
	HPT GWS Water Seal Drive Head	213368	Connects to push rods
	HPT Trunkline	214095	150 ft.
		214096	200 ft.
	Peristaltic GWS Hex Water Seal	218212	
	Hex HPT GWS Water Seal	216671	
	Heated MIHPT Hex Water Seal	218052	
	Hex Water Seal Spacer	219279	
	2.25 Adapter Weldment MBP Actuator	216627	

1.75 GROUNDWATER PROFILER

Probes

Components	Part	MN	Notes
	1.75 in. GWP Probe	230905	

Accessories

Components	Part	MN	Notes
	Friction Reducing Connection Tube NEW	234706	1.75 in. x 1.3 m
	Connection Tube NEW	234570	1.75 in. x 1.3 m
	Adapter 1.75 RHSL x 1.75 RHML NEW	234572	
	O-Ring (1.75 in. Probe Rod)	220387	Quantity: 25
	1.75 in. Adapter Weldment MBP Actuator	230360	
	GWP HPT Sensor Cable	230985	Used in up-hole configuration
	O-Ring (1.75 in. DI Probes)	223575	Quantity: 10

COMBINED COMPONENTS

Components	Part	MN	Notes
	HPT Spring Washer	215453	Quantity: 10
	HPT Screen Assembly	205558	
	MIP-HPT Screen Ratchet Wrench Assembly	212094	
	MIP-HPT Screen Ratchet Wrench Head Assembly	212095	
	HPT Sensor Module	210091	
	MSP Mechanical Syringe Pump NEW	234560	
	Mechanical Bladder Pump	214098	
	LDPE Tubing	601062	1/4 in. OD x 3/16 in. ID x 500 ft.
	HDPE Tubing NEW	114348	1/4 in. OD x .040 in. Wall x 500 ft.
	Polypropylene Tubing	601060	1/4 in. OD x 3/16 in. ID x 500 ft.
	FEP Tubing	214252	1/4 in. OD x 3/16 in. ID x 100 ft.
	Coupling HPT TL to HPT Sensor	107963	
	Band Clamp No. 7	220976	Quantity: 10
	MBP Service Kit	214112	
	MSP Service Kit NEW	236511	

Components	Part	MN	Notes
	MBP/MSP Barb Nose Intake	213376	
	MBP/MSP Electric Actuator	214106	12VDC
	Tubing Clamp Pair MBP Actuator	223584	.25 in.
	Slotted Seal Nut	216619	
	MSP Stainless Steel Piston	230993	
	O-Ring Installation Tool (MSP Piston) NEW	236023	
	MSP Piston O-Ring	230914	Quantity: 10
	MSP Piston Wear Ring NEW	233892	Quantity: 10
	MBP/MSP Check Ball Stainless Steel	103212	Quantity: 10
	MBP/MSP Heavy Compression Spring NEW	114347	
	O-Ring (MBP/MSP Lower Bladder Adapter) NEW	234553	Quantity: 25
	O-Ring (MBP Adapters)	214210	Quantity: 25
	MBP/MSP Top Seal NEW	234817	
	GWP to MBP/MSP Connector Tube NEW	235924	Quantity: 10

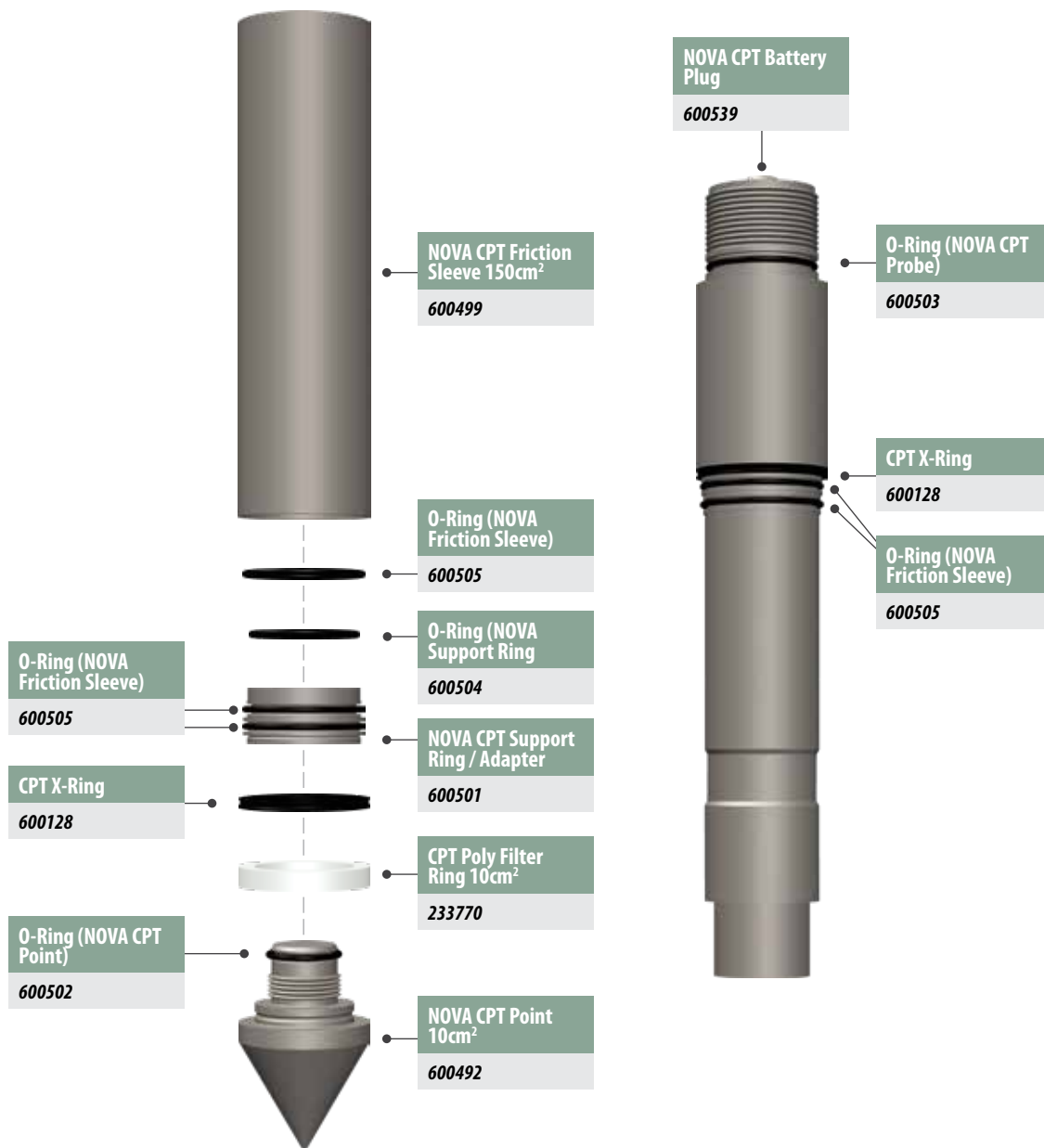

Accessories

Components	Part	MN	Notes
	NOVA CPT Point 10cm ²	600492	O-ring: 600502
	NOVA CPT Friction Sleeve 150cm ²	600499	
	NOVA CPT Support Ring / Adapter	600501	
	CPT Poly Filter Ring 10cm ² NEW	233770	Quantity: 10
	CPT X-Ring	600128	
	O-Ring (NOVA Friction Sleeve)	600505	Quantity: 10

Components	Part	MN	Notes
	O-Ring (NOVA Support Ring Inner)	600504	Quantity: 10
	O-Ring (NOVA CPT Point)	600502	
	O-Ring (NOVA CPT Probe)	600503	
	CPT Filter Ring	600125	Brass
	NOVA CPT Battery Plug	600539	



geoprobe.com/cpt

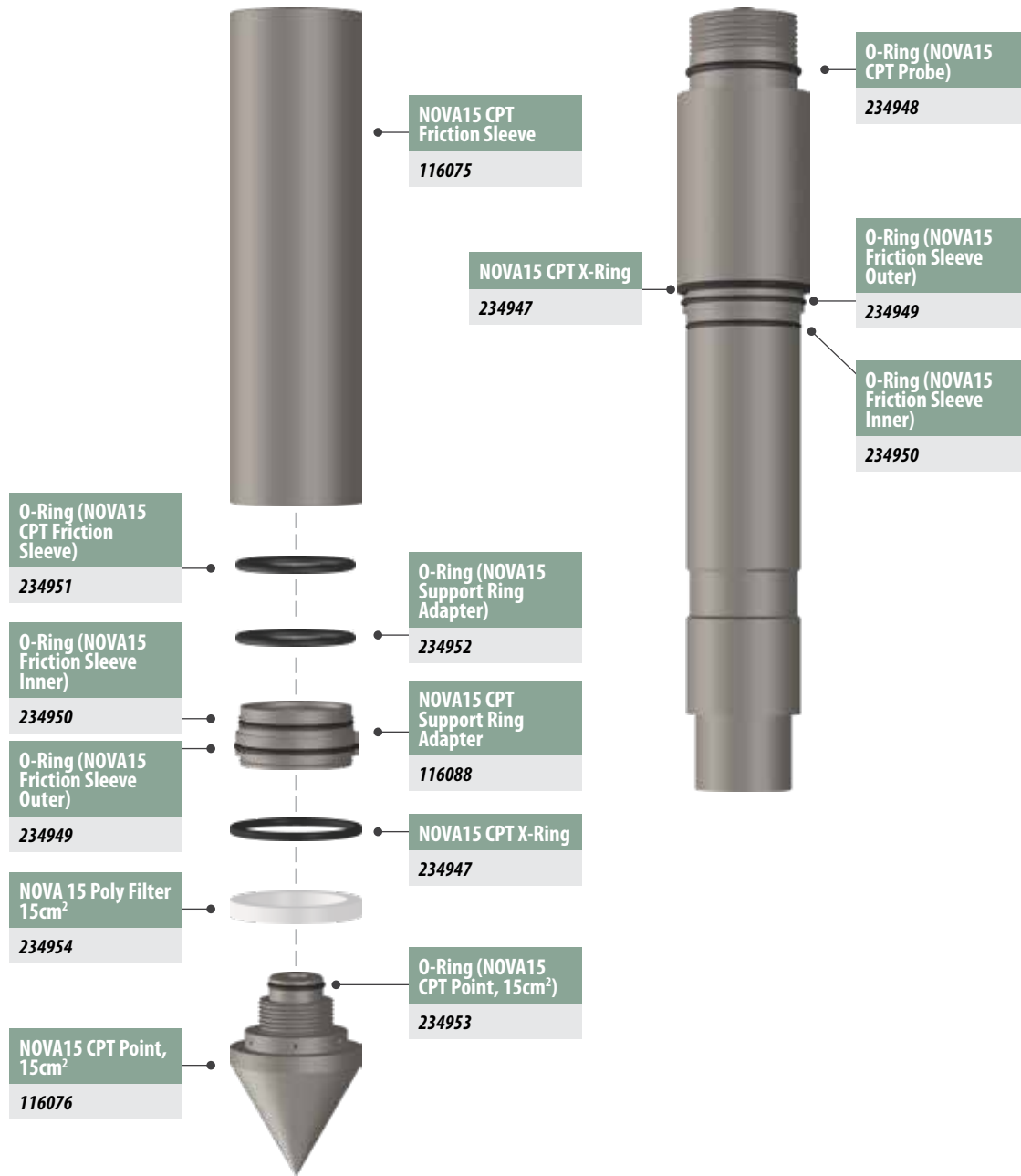

Accessories

Components	Part	MN	Notes
	NOVA15 CPT Friction Sleeve NEW	116075	
	NOVA15 CPT Point, 15cm ² NEW	116076	
	NOVA15 CPT Support Ring Adapter NEW	116088	
	NOVA15 CPT X-Ring NEW	234947	Quantity: 10
	NOVA 15 Poly Filter 15cm ² NEW	234954	Quantity: 10
	O-Ring (NOVA15 CPT Probe) NEW	234948	Quantity: 10

Components	Part	MN	Notes
	O-Ring (NOVA15 Friction Sleeve Outer) NEW	234949	Quantity: 10
	O-Ring (NOVA15 Friction Sleeve Inner) NEW	234950	Quantity: 10
	O-Ring (NOVA15 CPT Friction Sleeve) NEW	234951	Quantity: 10
	O-Ring (NOVA15 Support Ring Adapter) NEW	234952	Quantity: 10
	O-Ring (NOVA15 CPT Point, 15cm ²) NEW	234953	Quantity: 10



785-825-1842

geoprobe.com/cpt

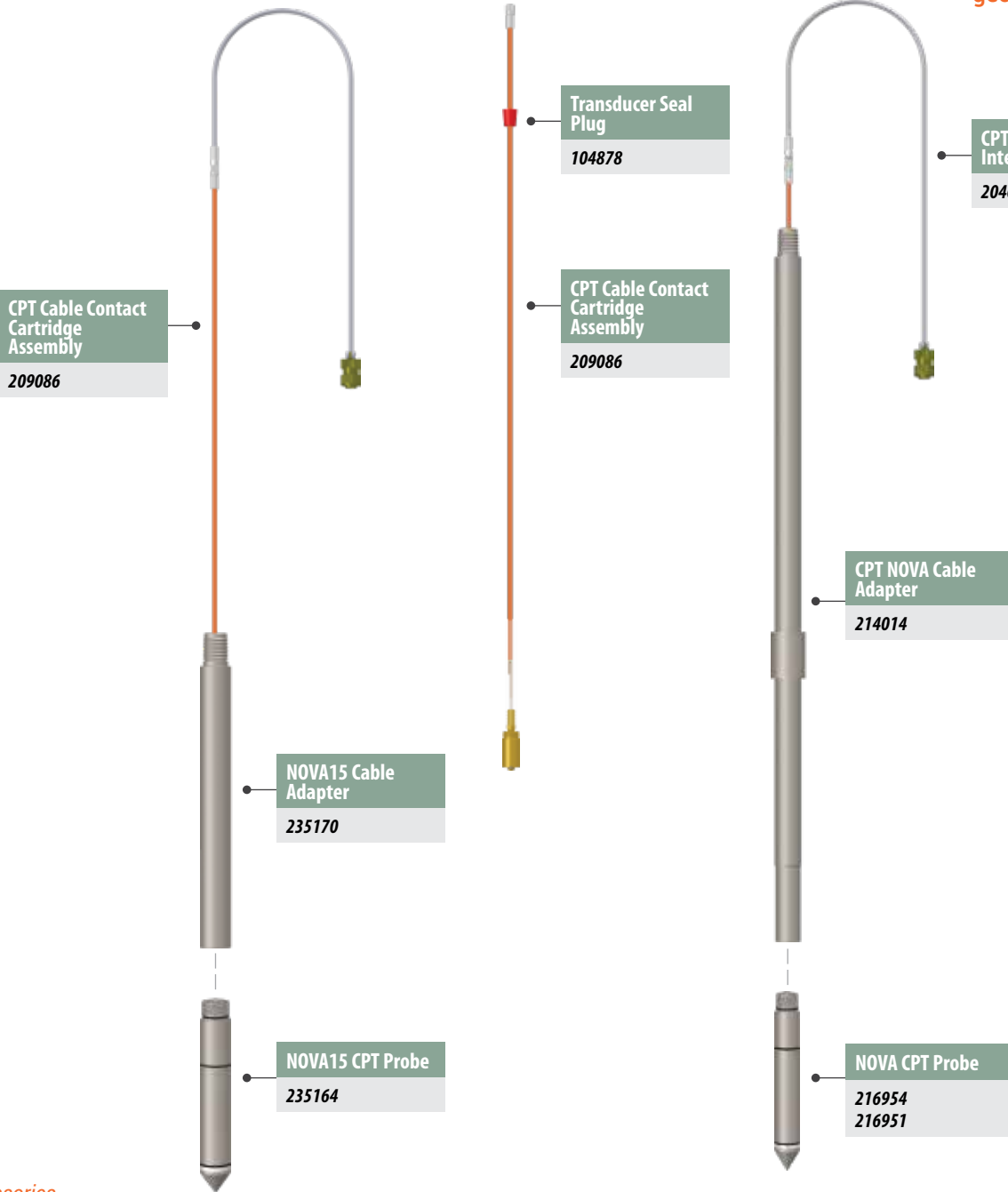

Accessories

Components	Part	MN	Notes
	NOVA15 CPT Probe NEW	235164	100, 1.5, 5.0, Tilt
	NOVA CPT Cable Probe	216954	100, 1.0, 2.0, Tilt
	NOVA CPT Probe	216951	100, 1.0, 5.0, Tilt (Custom)
	CPT NOVA Cable Adapter	214014	1.5 in. Rod Assembly
	NOVA15 Cable Adapter NEW	235170	
	NOVA15 CPT Cable Probe NEW	234930	100, 1.5, 5.0, Tilt

Components	Part	MN	Notes
	CPT Cable Contact Cartridge Assembly	209086	
	Soil Conductivity Probe Cord	214229	97 ft.
	CPT Cable to Interface Cord	204605	1 ft.
	Transducer Seal Plug	104878	
	1.75 in. Drive Head	220545	1.75 Box x 1.5 Pin



geoprobe.com/cpt

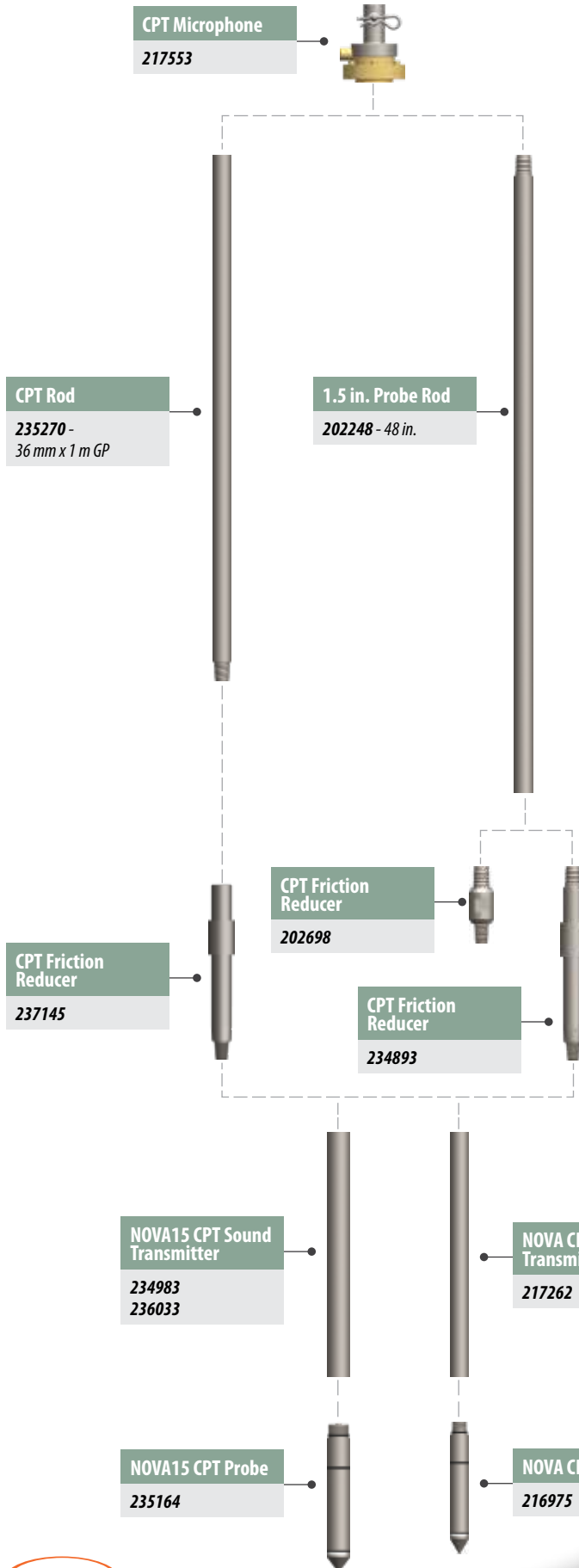

Accessories

Components	Part	MN	Notes
	CPT Microphone	217553	20 ton
	CPT Rod	NEW 235270	36 mm x 1 m GP, rope thread
	1.5 in. Probe Rod	202248	48 in.
	CPT Friction Reducer	NEW 237145	CPT/GP Box, 2 in. OD
	CPT Friction Reducer	202698	1.5/CPT
	NOVA15 CPT Sound Transmitter	NEW 234983	
	CPT Friction Reducer	NEW 234893	1.5/CPT, 12 in.
	NOVA15 Sound Transmitter	NEW 236033	44 mm Rod
	NOVA CPT Sound Transmitter	217262	
	NOVA15 CPT Probe	NEW 235164	100,1.5,5.0,Tilt
	NOVA CPT Probe	216975	Q=100 FS=1.0 U=2
	CPT Microphone Mount	202107	54 Series
	CPT Microphone Mount Top Bolt	201278	
	CPT Microphone Mount	203972	1-5/8 in. Hex
	CPT Microphone Mount	202548	GH60 Series
	NOVA CPT Mic Cable	206640	Cordless CPT 10cm ²

Geoprobe® CPT Platforms

geoprobe.com/cpt-platforms



This video takes a look at the various CPT platforms Geoprobe® has available.



785-825-1842

geoprobe.com/cpt

Seismic Sections

Components	Part	MN	Notes
	GP10 Seismic Section NEW	236237	
	GP10 Seismic Section, GP CPT Box NEW	239429	
	GP15 Seismic Section V2 NEW	238116	
	GP15 Seismic Section V2, GP CPT Box NEW	240664	

Replaceable Trigger Components

Components	Part	MN	Notes
	Seismic CPT Hammer with Trigger NEW	202781	
	Seismic Shear Plate	205448	
	Seismic CPT Shear Plate Cable NEW	236645	
	Seismic CPT Hammer NEW	236641	
	Seismic CPT Hammer Cable NEW	236614	
	Seismic CPT Trigger Connection Hub NEW	236643	
	Seismic CPT Trigger Cable NEW	236528	15 ft.
	Seismic CPT Trigger Hub Connection Cable NEW	236648	

Replaceable Interface Cables

Components	Part	MN	Notes
	DI Cordset 5 Cond NEW	236232	0.25 in. X 150 ft.
	Cable, 2m, USB "A" to Sealed USB "B" NEW	500965	
	GP Seismic Trunkline Adapter Cable NEW	236525	3 ft.
	Seismic CPT to CPT Cable NEW	235456	4 ft.
	Seismic CPT Trigger Cable NEW	236528	15 ft.

Probes

Components	Part	MN	Notes
	NOVA15 CPT Cable Probe NEW	234930	100, 1.5, 5.0, Tilt
	NOVA CPT Cable Probe	216954	100, 1.0, 2.0, Tilt
	NOVA CPT Probe	216975	100, 1.0, 2.0, Tilt
	NOVA CPT Probe	216951	100, 1.0, 5.0, Tilt (Custom)

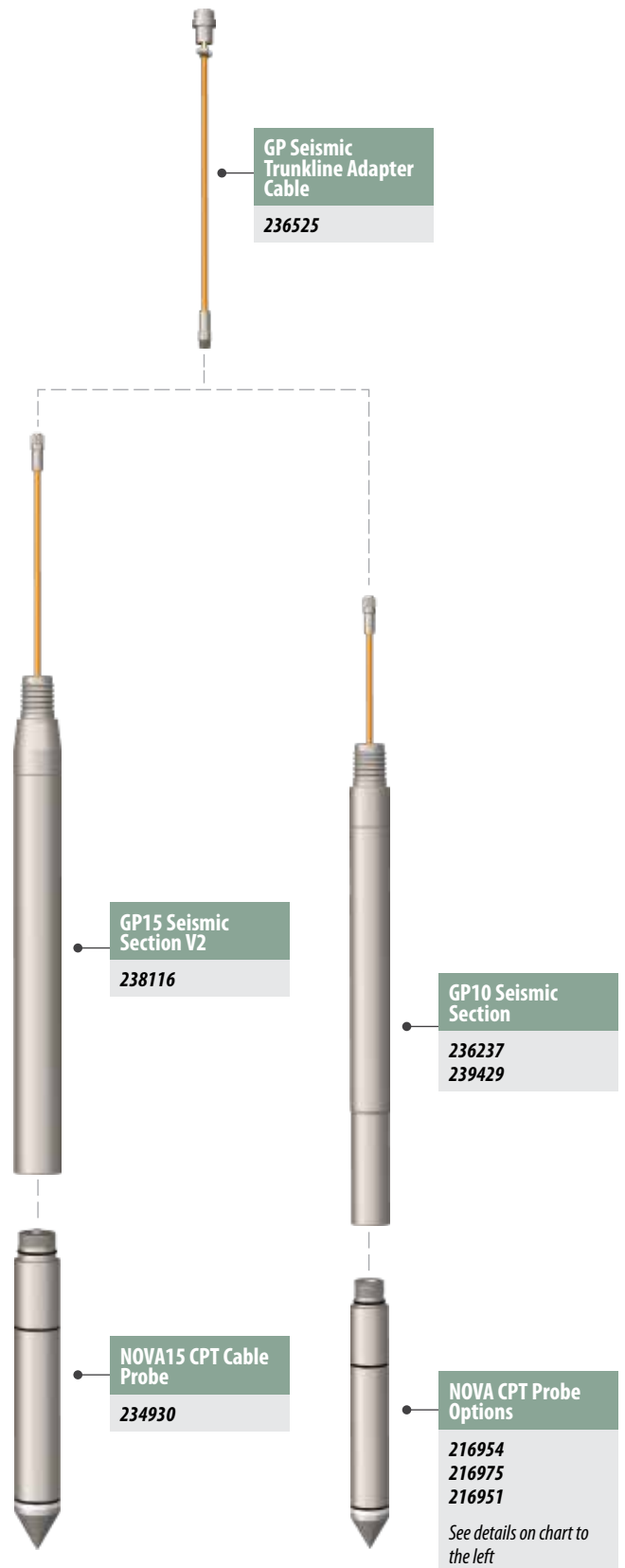

geoprobe.com/cpt

Interface & Cables

Components	Part	MN	Notes
	NOVA CPT Computer Interface	217259	
	USB to Serial Converter	103782	
	NOVA CPT Stringpot	235932	
	CPT Serial Cable	232928	3 ft.
	CPT Serial Cable	201292	20 ft.
	CPT Serial Cable	203435	35 ft.
	CPT Power Cable	234108	12V, 3 ft.
	CPT - Machine Power Cable	237095	12V, 9 ft.
	CPT Power Cable	202547	12V Plug
	NOVA CPT Mic Cable	232929	9 ft.
	NOVA CPT Mic Cable	206640	
	CPT Microphone Cable	201291	20 ft.
	NOVA CPT Stringpot Cable	232927	9 ft.
	NOVA CPT Stringpot Cable	216972	17 ft.
	NOVA CPT Stringpot Cable	209709	32 ft.

Friction Reducers and Adapters

Components	Part	MN	Notes
	CPT Friction Reducer	236659	1.5/1.5, 12 in.
	CPT Friction Reducer	234893	1.5/CPT, 12 in.
	CPT Friction Reducer	202698	1.5/CPT
	CPT Adapter	234841	CPT/1.5 Pin, 12 in.
	CPT Adapter	237140	CPT/GP Box
	CPT Friction Reducer	237145	CPT/GP Box, 2 in. OD
	NOVA CPT Rod with Friction Reducer	209663	
	CPT Friction Reducer	239033	GP/GP, 12 in., 2 in. OD

Anchors & Accessories

Components	Part	MN	Notes
	Soil Anchor	235227	10 in. Spiral, 1.625 Hex
	Soil Anchor	235239	15 in. Spiral, 1.625 Hex
	Soil Anchor Extension	205072	60 in.
	Soil Anchor Extension	235575	12 in. Spiral, Used for dual anchor
	Hex Extension	234097	12 in.
	CPT Anchor Bridge	239335	4 ft.
	CPT Anchor Footbridge	212131	Larger foot bridge
	CPT Bridge Weldment	231180	78/31 Series
	Soil Anchor Pinning Brackets	205209	Holds anchors against bridge

Accessories

Components	Part	MN	Notes
	HSA Auger Connecting Pin	600193	1-5/8 in. Hex, 77/66 Series Machines
	Rod Bushing CPT/1.5	205617	6625CPT
	CPT Rod Guide	231522	78/31 Series
	GP CPT Transport Case	219940	
	CPT - PRO Interpretation Software	600167	
	CPT Saturation Kit	205233	
	NOVA Memory Download USB Cable	206689	
	NOVA15 No-Go Gauge	236688	
	NOVA No-Go Gauge	236689	



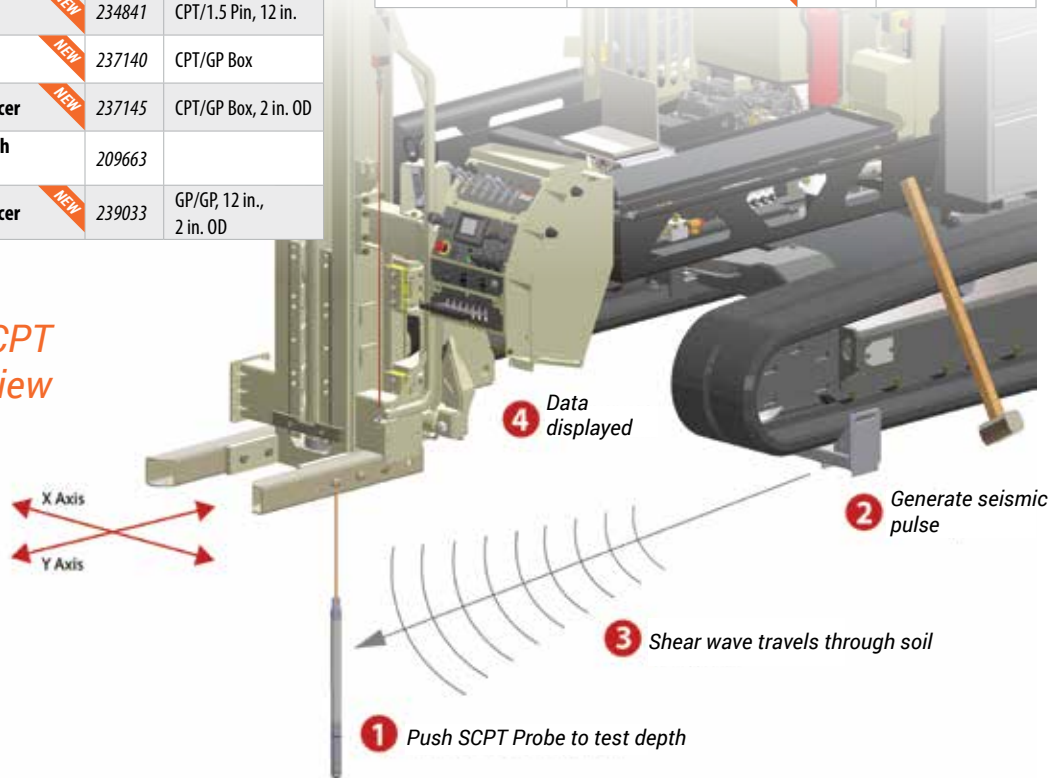

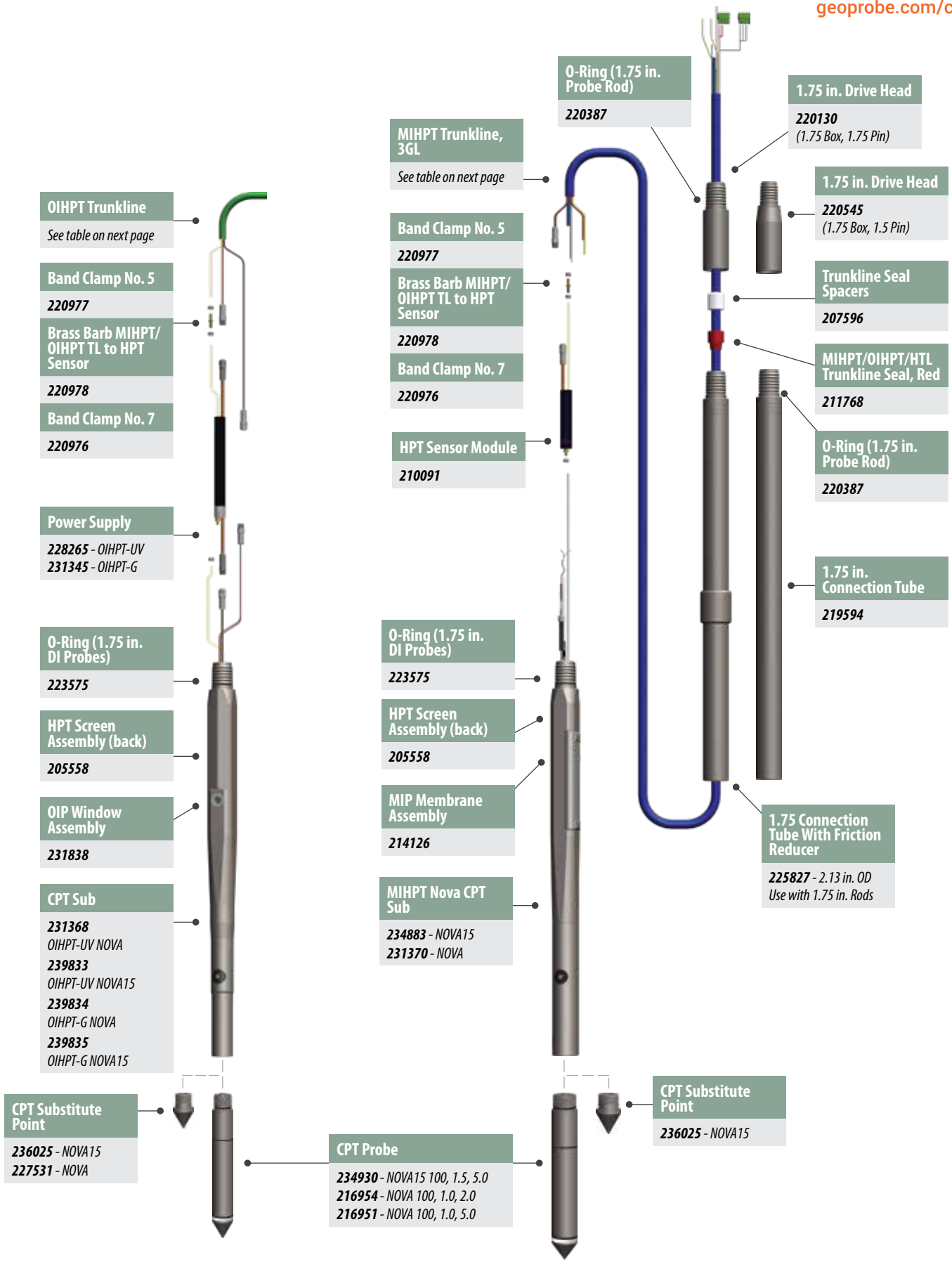

Seismic CPT Overview







Soil imaging probe and method of processing soil image to detect hydrocarbon contamination manufactured under US Patents 10,371,637 and 10,739,264



Subs

Components	Part	MN	Notes
	OIHPT-UV NOVA CPT Sub	231368	For 10cm ² Cone
	OIHPT-UV NOVA15 CPT Sub NEW	239833	For 15cm ² Cone
	OIHPT-G NOVA CPT Sub NEW	239834	For 10cm ² Cone
	OIHPT-G NOVA15 CPT Sub NEW	239835	For 15cm ² Cone
	MIHPT 15CM Nova CPT Sub NEW	234883	For 15cm ² Cone
	MIHPT Nova CPT Sub	231370	For 10cm ² Cone

Probes

Components	Part	MN	Notes
	NOVA CPT Cable Probe	216954	100, 1.0, 2.0, Tilt
	NOVA CPT Probe	216951	100, 1.0, 5.0, Tilt (Custom)
	NOVA15 CPT Cable Probe NEW	234930	100, 1.5, 5.0, Tilt

Trunklines & Accessories

Components	Part	MN	Notes
	OIHPT Trunkline	228253	100 ft.
		228254	150 ft.
		231482	200 ft.
	MIHPT Trunkline, 3GL	236309	100 ft.
		236310	150 ft.
		236311	200 ft.

Accessories

Components	Part	MN	Notes
	CPT Substitute Point NOVA Cone NEW	227531	
	CPT Substitute Point NOVA15 Cone	236025	
	OIP Window Assembly NEW	231838	4 mm
	MIP Membrane Assembly	214126	
	HPT Screen Assembly	205558	
	MIP-HPT Screen Ratchet Wrench Assembly	212094	
	OIP Window Ratchet Wrench Assembly	225140	
	OIHPT-UV Power Supply	228265	
	OIHPT-G Power Supply	231345	
	HPT Sensor Module	210091	
	Band Clamp No. 7	220976	Quantity: 10
	Brass Barb MIHPT/OIHPT TL to HPT Sensor	220978	Quantity: 5
	Band Clamp No. 5	220977	Quantity: 10
	1.75 Connection Tube With Friction Reducer	225827	2.13 in. OD
	1.75 in. Connection Tube	219594	
	1.75 in. Drive Head	220545	1.75 Box x 1.5 Pin
	1.75 in. Drive Head	220130	1.75 Box x 1.75 Pin
	MIHPT/OIHPT/HTL Trunkline Seal, Red	211768	
	Trunkline Seal Spacers	207596	Pair
	O-Ring (1.75 in. DI Probes)	223575	Quantity: 10

7822DT CPT Testing

geoprobe.com/7822dt



CPT testing with the 7822DT gives the rig even more capabilities.

3100GT CPT Testing

geoprobe.com/3100gt



The truck mounted 3100GT makes moving from site-to-site quick and easy.

3230DT CPT Testing

geoprobe.com/3230dt



See how the 3230DT combination rig is configured for CPT testing.

3126GT CPT Testing

geoprobe.com/3126gt



Watch how the 3126GT side-shift makes CPT testing simple.

Accessories

Components	Part	MN	Notes
	Electrical Vane Test Instrument/Gearbox	221266	
	Vane Transport Case - Instrument Motor	112835	
	Vane Instrument Mounting Ring	112889	
	Vane Log Logging Software for Windows	112836	
	Vane Power Cable	223010	12Vdc, 4A
	Vane Serial Cable	223014	RS232
	Vane Torque Wrench Control Instrument	112837	Optional for field confirmation
	Eurocode Field Vane	600468	65 mm x 130 mm
	2.25 in. Probe Rod	204778	1 m
		204777	12 in.
		206588	24 in.

Components	Part	MN	Notes
	Vane Inner Ext Rods (22 mm x 1000 mm)	112886	
	Adapter 2.25 Pin x Geotech SPT Pin	213295	Adapts Eurocode sheath to rods
	Vane Gearbox 2.25 in. Rod Clamp	221557	For mounting gearbox to casing
	Vane (65 mm x 130 mm)	600509	Vane Blade
	Vane (50 mm x 110 mm)	601086	Vane Blade
	Vane Slip Coupling	600510	
	Field Vane Sheath Seal	600497	Repair Part
	Vane Slip Coupling Rubber Boot	112261	Repair Part
	Vane Slip Coupling Needle Bearings	112683	Repair Part
	Vane Slip Coupling Pin	112684	Repair Part



Watch this video to learn about our dual flight anchors.

Single bridge with dual anchor



4-ft. bridge (2-anchor)



Accessories

Components	Part	MN	Notes
	CPT Rod Guide Assembly NEW	239467	78/31 Series
	Soil Anchor Pinning Brackets	205209	Holds anchors against bridge
	Single CPT Bridge Weldment NEW	231180	78/31 Series
	Soil Anchor Extension NEW	235575	12 in. Spiral, Used for dual anchor
	Soil Anchor NEW	235227	10 in. Spiral, 1.625 Hex
	Soil Anchor Extension	205072	60 in.
	Soil Anchor NEW	235239	15 in. Spiral, 1.625 Hex
	CPT Anchor Bridge NEW	239335	4 ft.
	CPT Anchor Footbridge	212131	Larger foot bridge
	HSA Auger Connecting Pin	600193	1-5/8 in. Hex, 77/66 Series Machines

geoprobe.com/grout-sub

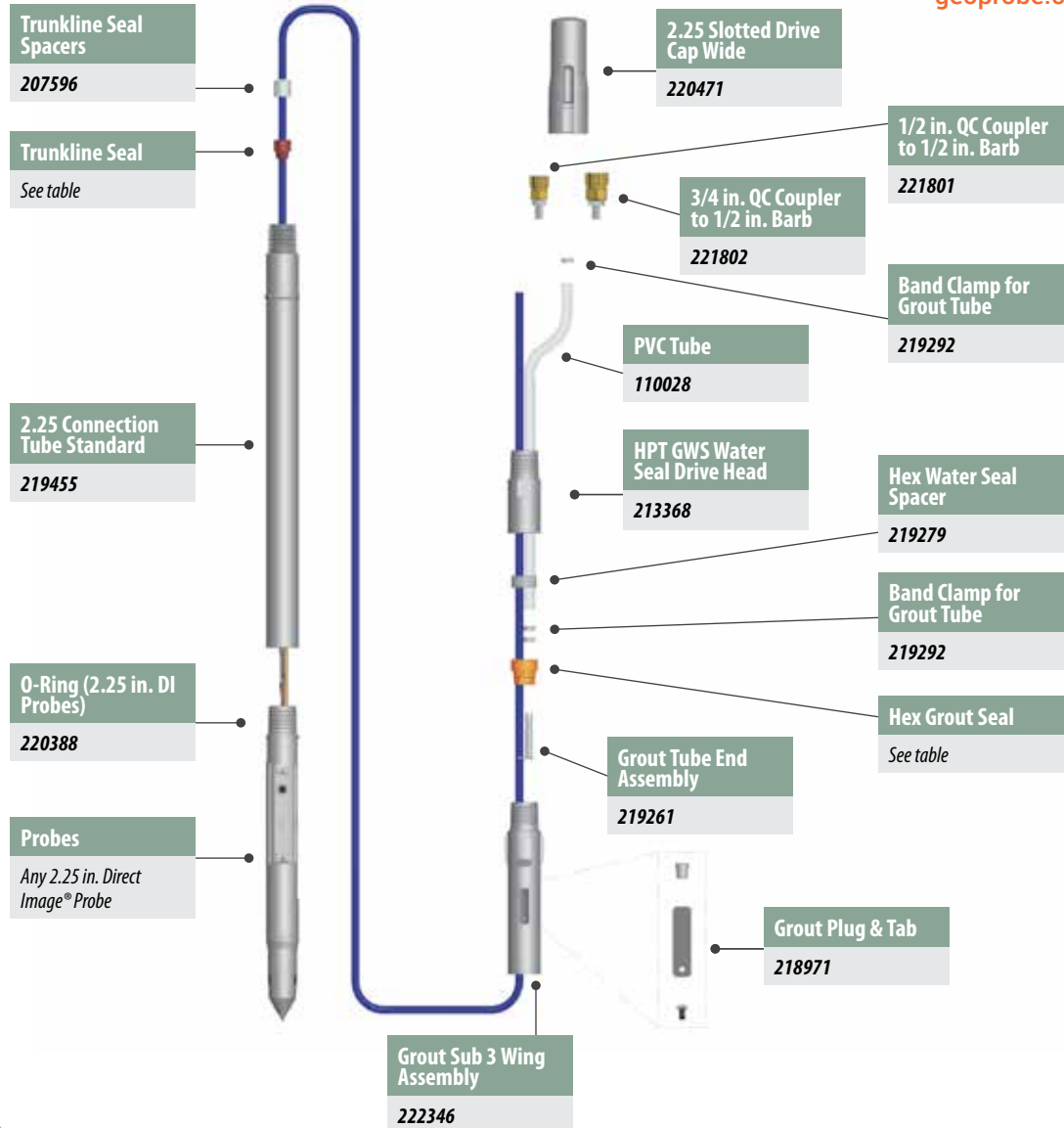

Accessories

Components	Part	MN	Notes
	Grout Sub 3 Wing Assembly	222346	
	Grout Plug & Tab	218971	Quantity: 5
	Hex Grout Seal EC	222491	For EC trunkline
	Hex Grout Seal MIHPT	222489	For MIHPT trunkline
	Hex Water Seal Spacer	219279	
	HPT GWS Water Seal Drive Head	213368	Connects to push rods
	Grout Tube End Assembly	219261	
	PVC Tube	110028	1/2 in. x .728 in. OD x 500 ft.

Components	Part	MN	Notes
	Band Clamp for Grout Tube	219292	Quantity: 10
	2.25 Connection Tube Standard	219455	
	MIHPT/OIHPT/HTL Trunkline Seal, Red	211768	
	MIP/OIP Trunkline Seal, Yellow	207773	
	HPT Trunkline Seal, Orange	207772	
	Trunkline Seal Spacers	207596	Pair
	3/4 in. QC Coupler to 1/2 in. Barb	221802	
	1/2 in. QC Coupler to 1/2 in. Barb	221801	
	2.25 Slotted Drive Cap Wide	220471	Threadless

Accessories





Components	Part	MN	Notes
	MIP Service Kit	214142	
	OIP Service Kit	226361	
	HPT Service Kit	205599	
	MIP Membrane Assembly	214126	
	Copper Washer Seal	102520	0.79 in. OD
	HPT Screen Assembly	205558	
	HPT Spring Washer	215453	Quantity: 10
	OIP Window Assembly	231838	4 mm
	OIP Window Seals	224959	Quantity: 10
	MIP-HPT Screen Ratchet Wrench Assembly	212094	
	MIP-HPT Screen Ratchet Wrench Head Assembly	212095	
	OIP Window Ratchet Wrench Assembly	225140	
	OIP Window Ratchet Wrench Head Assembly	225139	
	MIP Thermocouple Assembly	208045	
	HPT Sensor Module	210091	
	OIHPT-UV Power Supply	228265	
	OIHPT-G Power Supply	231345	
	MIHPT/OIHPT/HTL Trunkline Seal, Red	211768	
	HPT Trunkline Seal, Orange	207772	
	MIP/OIP Trunkline Seal, Yellow	207773	
	EC Trunkline Seal, Green	209568	
	Trunkline Seal Spacers	207596	Pair
	EC Dipole Tester	205724	
	EC Test Load, 3 Level Test	208075	
	Wenner Array Probe Test Jig	214237	
	Four Sided Cuvette Holder Assembly	225952	
	Cuvette Quartz 3500 uL	112784	Quantity: 2
	HPT Reference Cylinder	212689	For 1.75 in. and smaller probes
	HPT Reference Cylinder	211762	For 2.25 in. probes
	Nut Hex BRS 1/16 in. Comp Tube	210557	Quantity: 10
	Ferrule Set Brass 1/16 in.	210555	Quantity: 10
	MP6520 Probe Butt Conn Green	208657	Quantity: 10
	MP6520 Probe Butt Conn Red	208658	Quantity: 10
	Term Block 4 Pos, Green	101465	

Components	Part	MN	Notes
	MIP 120V TL Heater Connector	112805	
	Conn Thermocouple "K" Type Male	101498	
	Band Clamp No. 7	220976	Quantity: 10
	Band Clamp No. 5	220977	Quantity: 10
	HPT Controller Test Load	206552	
	OIP Test Load	228240	
	MIP Breakout Connection Panel	211100	
	MIP Soil Gas Response Test Jig	231500	
	Membrane Pocket Resurfacing Tool	235648	
	Membrane Pocket Resurfacing Disk	235926	Quantity: 20
	MIP Nafion Dryer Tube	600150	SS, 24 in. LG
	Benchtop Instrument Rack	230892	
	Direct Image® ATV Instrument Carrier	223509	
	Connection Tube LB Pin and Box	206304	
	1.75 in. Drive Head	220966	LB Box x 1.75 Pin
	LIF Water Seal Adapter, LB Pin X RHSL 1.75 Pin	220968	2.48 in. S-S
	62-Pin Serial Cable	105475	
	USB Type B Cable - Sealed	104158	5 m
	USB Cable	104788	2 m
	GPS Receiver USB FI Based Use	106989	
	USB to Serial Converter	103782	
	Sinewave Inverter 12VD-C/120VAC/300W	107479	
	DI Connection Tube Wire Sleeve	233978	Quantity: 20

















Rod Rack Parts

Components	Part	MN	Notes
	1.25/1.5 Cable Rod Rack Weldment	203088	Holds 18 rods
	1.25/1.5 Cable Rod Rack Weldment	203121	Holds 30 rods
	1.75 Cable Rod Rack Weldment	220961	Holds 27 rods
	Cable Rod Rack Assembly (2.25 in. Rods)	206973	Holds 21 rods
	Roll Out Rod Rack Base	214532	96 in. base
	Roll Out Rod Rack Base	240760	76 in. base
	Cable Rod Rack Assembly (1.25/1.5 in. Rods)	203808	Holds 30 rods
	Cable Rod Rack Base Assembly	222325	

Stringpot & Accessories

Components	Part	MN	Notes
	Stringpot Assembly Cable	214227	100 in.
		214228	30 ft.
	Stringpot Cordset	202884	65 ft.
		203836	100 ft.
	Stringpot Ground Plate	220775	
	Stringpot Replacement Cable	600464	100 in.
	Stringpot Replacement Cable	101032	80 in.
	Lanyard Cable Assembly	100069	
	Stringpot Mounting Bracket	209511	78 Series
	Stringpot Mounting Bracket	202947	66 Series
	Stringpot Piston Weight Foot Bracket	201816	66 Series
	Stringpot Piston Weight Foot Bracket	209533	78 Series
	Stringpot Piston Weight Assembly	214225	

Drive Cushion

Components	Part	MN	Notes
	Drive Cushion	221775	Use with GH60 Drive Cap
	Drive Cushion Bottom Plate	221155	GH60
	Drive Cushion	204278	Use with GH40 Drive Cap
	Drive Cushion Bottom Plate	204117	GH40
	Drive Cushion Top Plate	204116	
	31 Series GH60 Drive Cushion Asm*	239873	
	Drive Cushion Top Plate 31 Series*	239752	Compatible with other drive cushion assemblies
	Lower Striker Retainer Sleeve	239729	
	Drive Cushion Phenolic Insert	204277	
	Drive Cushion Nylon Insert	204608	
	Drive Cushion Retaining Ring Cap	204276	
	O-Ring (Drive cushion retaining ring)	103319	
	Drive Cushion Retaining Ring	204275	2 pc.
	O-Ring (Hex Anvil Retainer Cap)	105794	
	Hex Anvil Retainer Pin	202888	GH60 Series
	Heavy Load Silicon Steel Die Spring	103318	
	Hardware Pack for Drive Cushion Rebuild	238586	

* For use with 31GT machines only. Requires 239729 change-out on some machines. Call for compatibility.

DI







Pneumatic Slug Test

Components





Geoprobe

785-825-1842

Accessories

Components	Part	MN	Notes
	Pneumatic Slug Test Kit	214038	
	Slug Test Acquisition Module, USB	220971	
	Slug Testing 15PSI Transducer	216870	100 ft. Cable
	Slug Test Transducer Seal	207872	
	Copper Washer Seal	102520	0.79 in. OD
	Slug Test Manifold Asm.	203153	
	Manual Hand Vac Pump with Gauge	600711	16CC

geoprobe.com/pst

Components	Part	MN	Notes
	Slug Test Hand Pump Air Hose	211224	
	Slug Test PVC Adapter Kit	214039	
	Slug Test 2 in. Well Head Adapter Asm.	207304	
	Pressure Gauge 0"-60"IN/ H2O PRES 2.5"x1/4 DUAL SCL	102760	
	Vacuum Gauge 60"-0" H2O 2.5 FACE	104501	
	QC Plug Air	102823	1/8 in. x 1/4 in. FPT

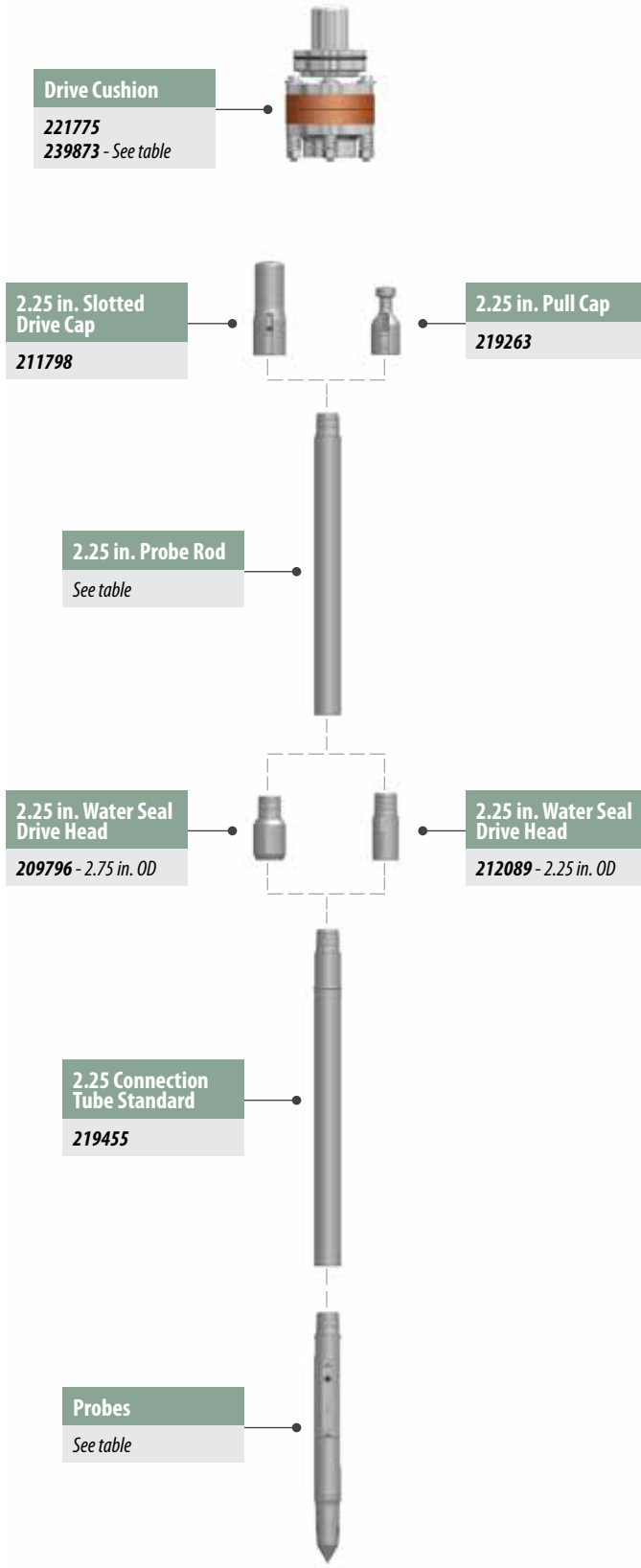

Components	Part	MN	Notes
	2.25 in. Slotted Drive Cap	211798	GH60, Threadless
	2.25 in. Pull Cap	219263	Slotted
	2.25 in. Slotted Drive Adapter	209807	
	2.25 in. Probe Rod	204767	60 in.
		204766	48 in.
		206706	36 in.
		206588	24 in.
		204778	1 m
	O-Ring (2.25 in. Probe Rod)	213790	Quantity: 25
	2.25 in. Water Seal Drive Head	209796	2.75 in. OD
	2.25 in. Water Seal Drive Head	212089	2.25 in. OD
	2.25 Connection Tube Standard	219455	
	Rod Wiper Weldment	204387	
	Rod Wiper Donut	600412	2.25 in. (Weldment: 204387)
	RG Handle Assembly	205664	2.25 in., GH60
	RG Jaw	205565	2.25 in., GH60
	Drive Cushion	221775	Use with GH60 Drive Cap
	31 Series GH60 Drive Cushion Asm*	239873	

* For use with 31GT machines only. Requires 239729 change-out on some machines. Call for compatibility.

Probes

Components	Part	MN	Notes
	MIHPT Probe	214117	2.25 in.
	HPT Probe	214097	2.25 in.
	2.25 in. HPT Groundwater Sampler	216100	

geoprobe.com/di-probe-rods

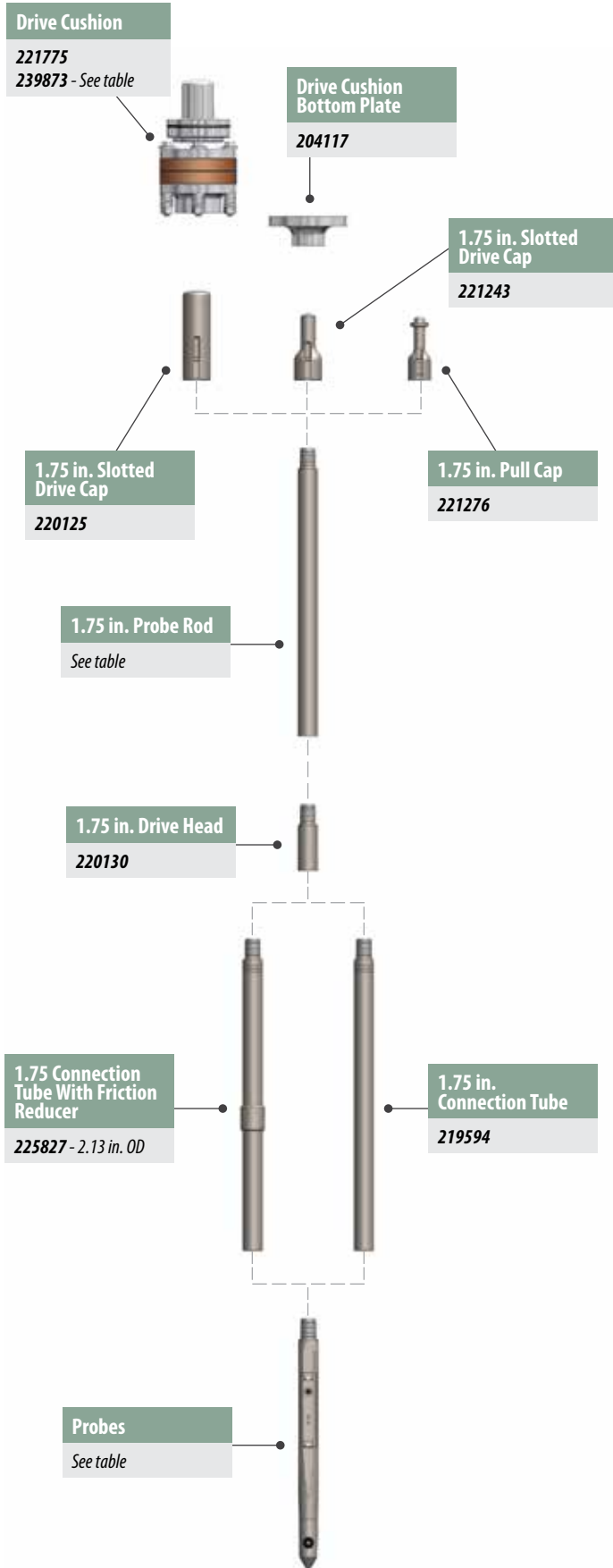

Components	Part	MN	Notes
	1.75 in. Slotted Drive Cap	220125	GH60, Threadless
	1.75 in. Slotted Drive Cap	221243	GH40, Threadless
	1.75 in. Pull Cap	221276	Slotted
	1.75 in. Probe Rod	220032	60 in.
	1.75 in. Probe Rod	220746	48 in.
	1.75 in. Drive Head	220130	1.75 Box x 1.75 Pin
	1.75 Connection Tube With Friction Reducer	225827	2.13 in. OD
	1.75 in. Connection Tube	219594	
	Connection Tube LB Pin and Box	206304	
	1.75 in. Drive Head	220966	LB Box x 1.75 Pin
	Rod Wiper Weldment	204387	
	Rod Wiper Donut	600341	1.25 in. / 1.5 in. / 1.75 in.
	RG Handle Assembly	220912	1.75 in., GH60
	RG Jaw	220259	1.75 in., GH60
	Drive Cushion	221775	Use with GH60 Drive Cap
	Drive Cushion Bottom Plate	204117	GH40
	31 Series GH60 Drive Cushion Asm*	239873	NEW

* For use with 31GT machines only. Requires 239729 change-out on some machines. Call for compatibility.

Probes

Components	Part	MN	Notes
	MIHPT Probe Square	226720	1.75 in.
	OIHPT-UV Probe	227466	UV275
	OIHPT-G Probe	231346	GL525
	HPT Probe	226553	1.75 in.

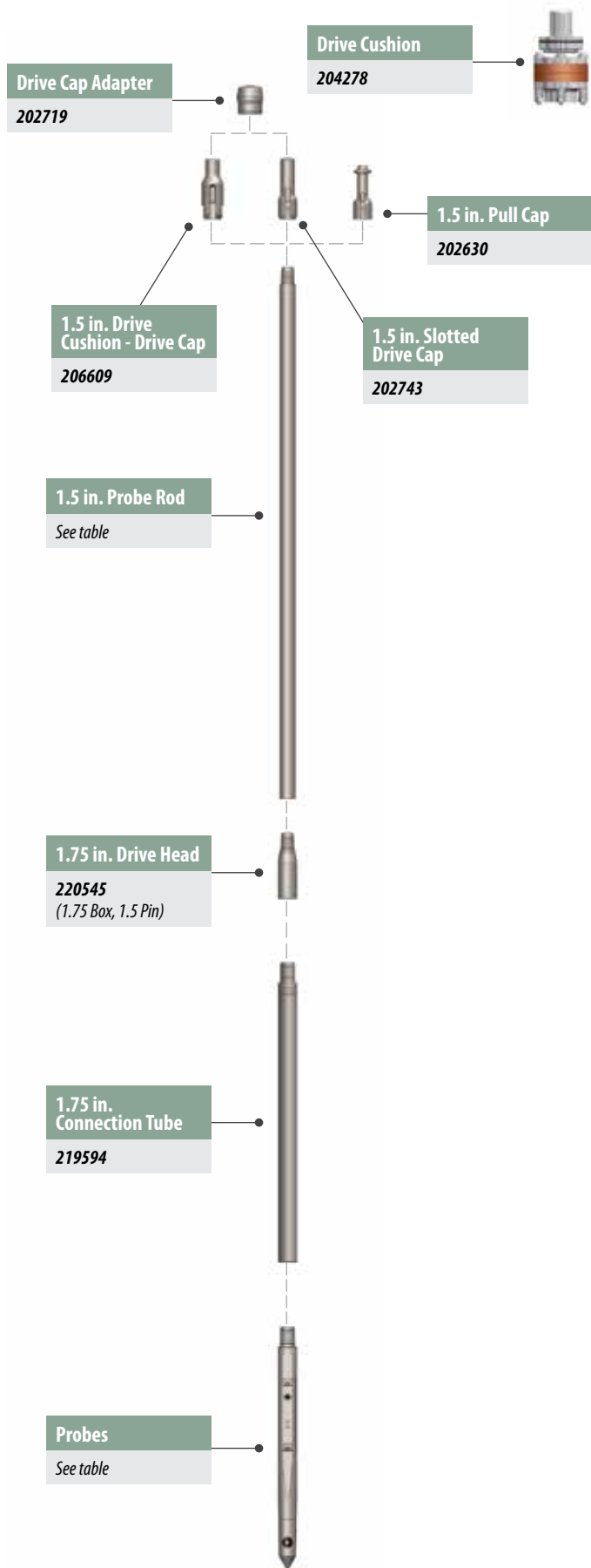

Components	Part	MN	Notes
	Drive Cap Adapter	202719	GH40 to GH60 Series
	1.5 in. Drive Cushion	206609	Slotted, Threadless
	1.5 in. Slotted Drive Cap	202743	GH40, Threaded
	1.5 in. Pull Cap	202630	Slotted
	1.5 in. Probe Rod	201682	60 in.
		202248	48 in.
		207261	36 in.
		202715	24 in.
		203193	1 m
	1.75 in. Drive Head	220545	1.75 Box x 1.5 Pin
	1.75 in. Connection Tube	219594	
	Connection Tube LB Pin and Box	206304	
	LB Box x 1.5 Pin	203794	3.73 in. S-S
	Rod Wiper Weldment	204387	
	Rod Wiper Donut	600341	1.25 in. / 1.5 in. / 1.75 in.
	RG Handle Assembly	202724	1.25 in. / 1.5 in., GH60
	RG Jaw	202660	1.25 in. / 1.5 in., GH60
	Drive Cushion	204278	Use with GH40 Drive Cap

Probes

Components	Part	MN	Notes
	MIHPT Probe Square	226720	1.75 in.
	OIHPT-UV Probe	227466	UV275
	OIHPT-G Probe	231346	GL525
	HPT Probe	226553	1.75 in.

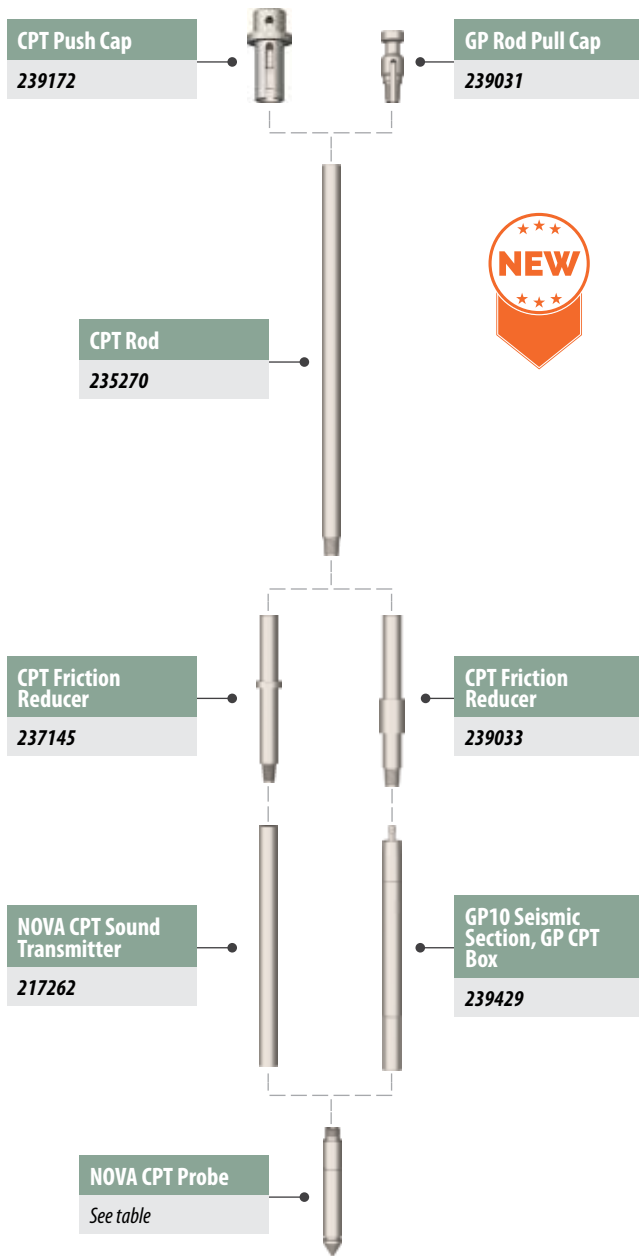

Components	Part	MN	Notes
	CPT Push Cap	NEW 239172	GH60, hammer face
	GP Rod Pull Cap	NEW 239031	Slotted, pin down
	CPT Rod	NEW 235270	36 mm x 1 m GP, rope thread
	CPT Friction Reducer	NEW 237145	CPT/GP Box, 2 in. OD
	CPT Friction Reducer	NEW 239033	GP/GP, 12 in., 2 in. OD
	CPT Friction Reducer	NEW 114937	SPL/SPL Ring
	NOVA CPT Sound Transmitter	217262	Cordless CPT 10cm ²

geoprobe.com/di-probe-rods

Actual Size

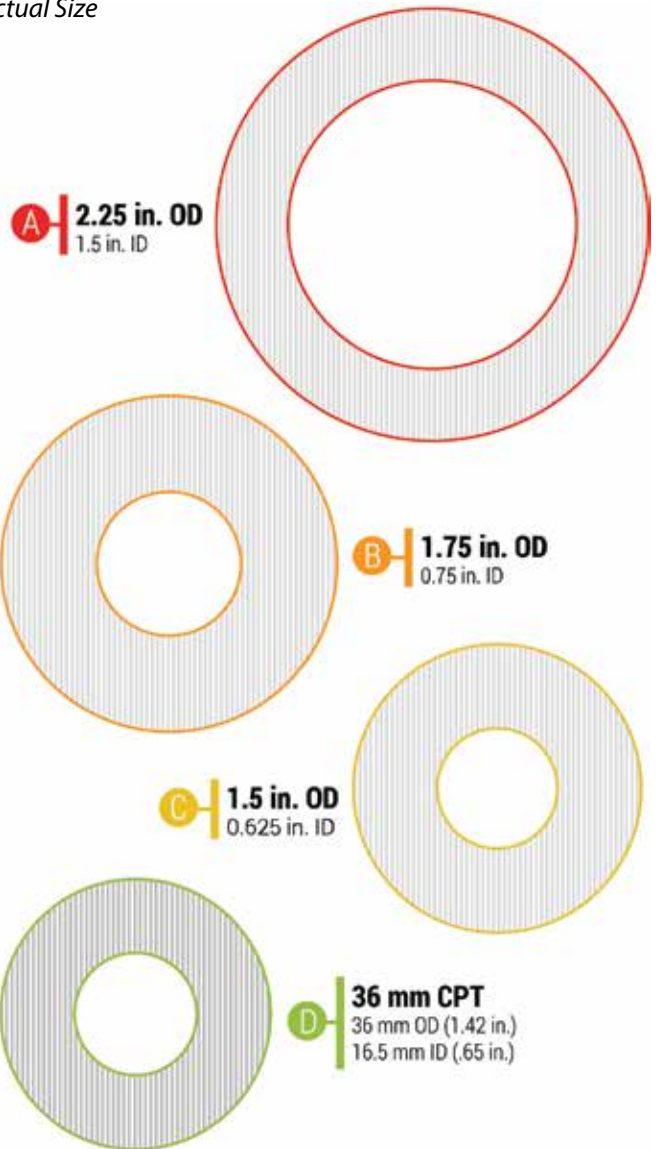

Components	Part	MN	Notes
	GP10 Seismic Section, GP CPT Box	NEW 239429	Use with CPT rods
	Rod Wiper Donut	600341	1.25 in. / 1.5 in. / 1.75 in.
	RG Handle Assembly	202724	1.25 in. / 1.5 in., GH60

Probes

Components	Part	MN	Notes
	NOVA CPT Probe	216975	Q=100 FS=1.0 U=2
	NOVA CPT Cable Probe	216954	100, 1.0, 2.0, Tilt
	NOVA CPT Probe	216951	100, 1.0, 5.0, Tilt (Custom)